



People's Liberation Army Navy Nuclear Submarines



Christopher P. Carlson

Historicon 2023

Admiralty Trilogy Seminar

19 October 2023 Update



PLAN Nuclear Submarines

- ◆ China's pursuit of nuclear-powered submarines was rooted in self-reliance to produce the reactor, propulsion plant, as well as the rest of the submarine's systems without outside assistance.
- ◆ The Soviet Union repeatedly denied providing technical assistance.
 - Ironic as Russia began providing significant support in the mid-1990s.
- ◆ China started its journey in October 1958 by poring over any scrap of information that could be obtained from textbooks, articles, even toys.
- ◆ The first Type 09I was completed and commissioned into service in August 1974 but despite being called a great triumph, the boat was a disaster.
- ◆ Over the next 49 years, China's nuclear submarines would slowly improve, with the PLAN now on the cusp of producing world class submarines.



Huang Xuhua with the USS *George Washington* SSBN model by Renwal



China's Imposed Self-Reliance

- ◆ By mid-1958 China had a strong desire to develop and build nuclear-powered submarines and submarine-launched ballistic missiles.
 - July 1958: Project 09 approved.
 - October 1958: Overall design section formed.
 - Soviet technical assistance would be crucial to China's success and was pursued with vigor.
 - Soviet Union repeatedly denied providing the needed assistance – concerned about long-range weaponry.
- ◆ Khrushchev and Mao's relationship was at best strained.
 - Neither liked or trusted the other.
 - Mao feared Russian efforts to dominate China.
 - Khrushchev regarded cooperation as a two-way street.
- ◆ October 1959: Khrushchev impolitely claimed China couldn't build nuclear submarines.
- ◆ "We will have to build nuclear submarines even if it takes us 10,000 years!" – Mao Zedong





China's Rocky Road

- ◆ Progress was slow due to:
 - A lack of engineering experience and industrial capacity.
 - Competition with nuclear weapons development programs for people and funding.
 - Political and economic chaos from Mao's Great Leap Forward.
- ◆ Project 09 postponed in March 1963.
 - Priority given to nuclear weapons development.
 - Small cadre of engineers retained to explore technical options for nuclear reactors and overall submarine design.
 - Continued gathering open-source data.
- ◆ October 16, 1964: China detonates its first nuclear weapon.
- ◆ March 1965: Project 09 restarted.
- ◆ November 1968: Lead Type 09I laid down.



Zhao Renkai, Peng Shilu, Huang Weilu, Huang Xuhua



Choosing a Reactor Design

Otto Hahn
Integrated Reactor

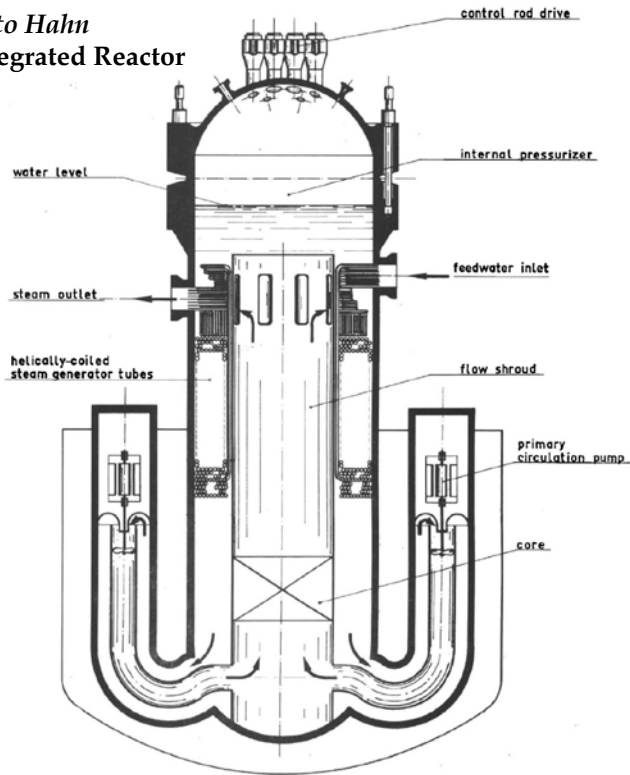

Lenin OK-150 Loop Type Reactor

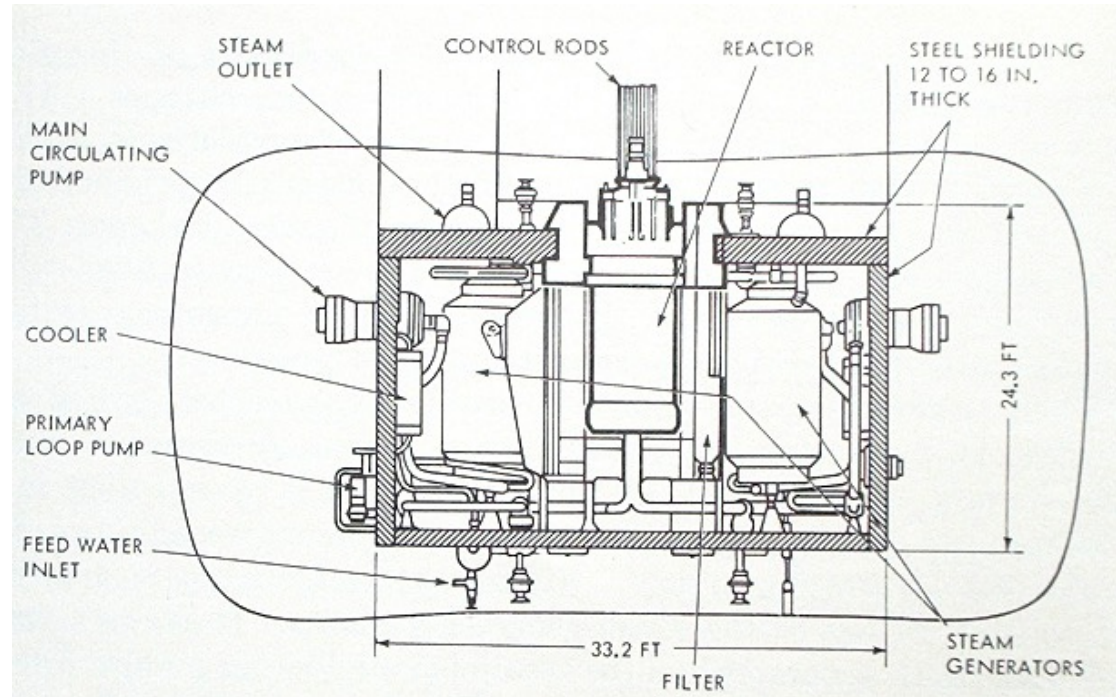

- ◆ Four civilian marine reactor plants were examined for the Type 09 submarines.
 - *Otto Hahn* (West Germany), *Savannah* (U.S.), *Lenin* (Soviet Union), and possibly *Mutsu* (Japan).
- ◆ A loop type reactor was chosen as it would be easier to build.
 - *Otto Hahn* was an integrated reactor design; theoretically superior, but far more complex.
- ◆ Many references suggest the Soviet OK-150 reactor plant was adopted.



Choosing a Reactor Design

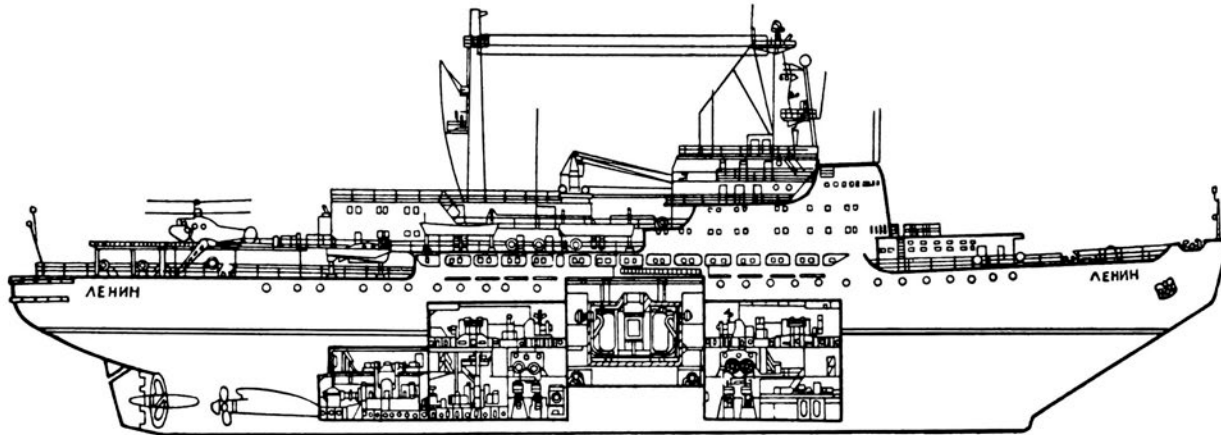

Soviet Icebreaker *Lenin*

- ◆ OK-150 plant is too large to fit in the Type 09I pressure hull diameter of 9 meters.
 - OK-150 is 32.7 feet tall (w/CRDM height) and 33.2 feet wide (≈ 10 meters x 10 meters).
 - OK-150 reactor maximum power rating is 90 MW (thermal), w/24-25 control rods.
- ◆ Interestingly, Type 09I reactor vessel and steam generator designs bear a strong resemblance to the *Mutsu* plant.
 - *Mutsu* reactor maximum power rating is 36 MW (thermal), w/12 control rods.

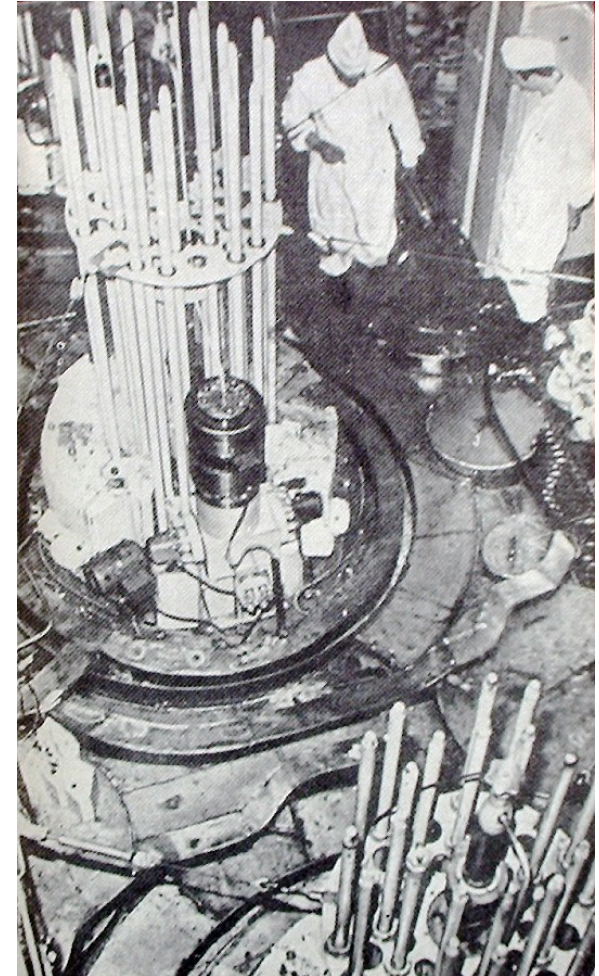

OK-150 Reactors



Type 09I Reactor

Type 09I Reactor Vessel

Type 09I Reactor Vessel Diagram



- ◆ Type 09I reactor vessel is a little smaller in diameter than OK-150 and has 19 control rods.
- ◆ Maximum rated power is 48 MW (thermal).
 - Later increased to 58 MW (thermal) for Type 09II and later Type 09I submarines.



Type 09I Reactor Plant Control Panel



Type 09I Reactor Plant Display Qingdao Museum

Type 09I Primary Loop Mockup

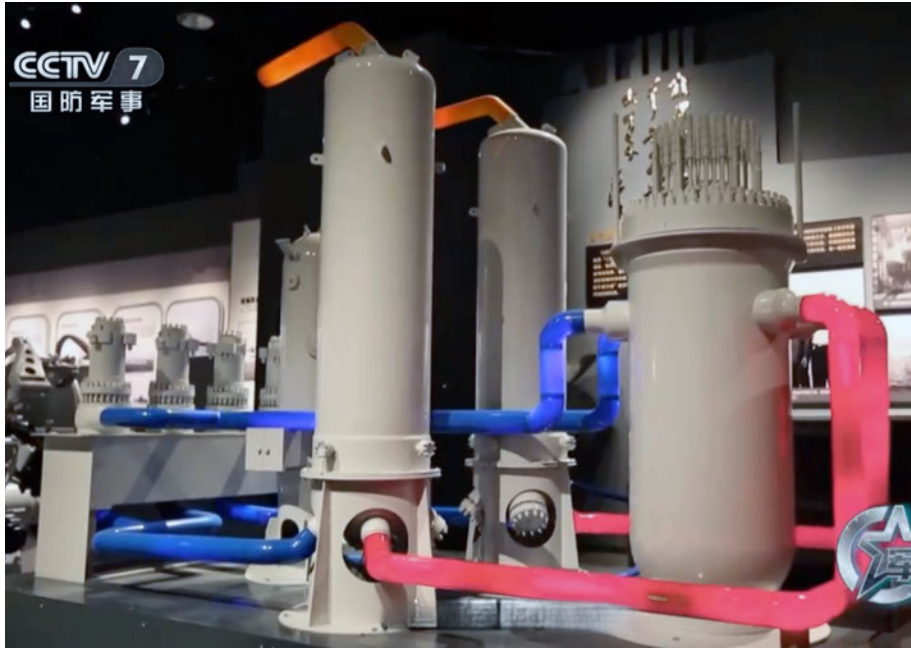

Steam Generator Model



Actual Steam Generator

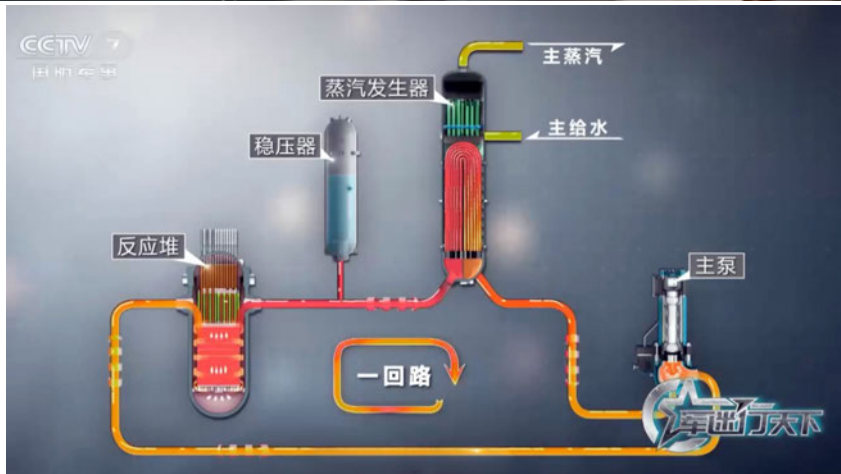



BSHIC Bohai Shipyard, Huludao



- ◆ The old construction hall at the Bohai shipyard had two building ways dedicated to submarine construction.
 - 1969 - 1987: Produced five Type 09I and one Type 09II submarines.
 - 1988 - 1998: No submarines under construction. (Deng Xiaoping disinterest)
 - 1999 - 2018: Produced six Type 09III/09IIIA and six Type 09IV submarines.
- ◆ Around 2020 construction began at the new facility across the bay.
 - First submarine rolled out in January 2023.

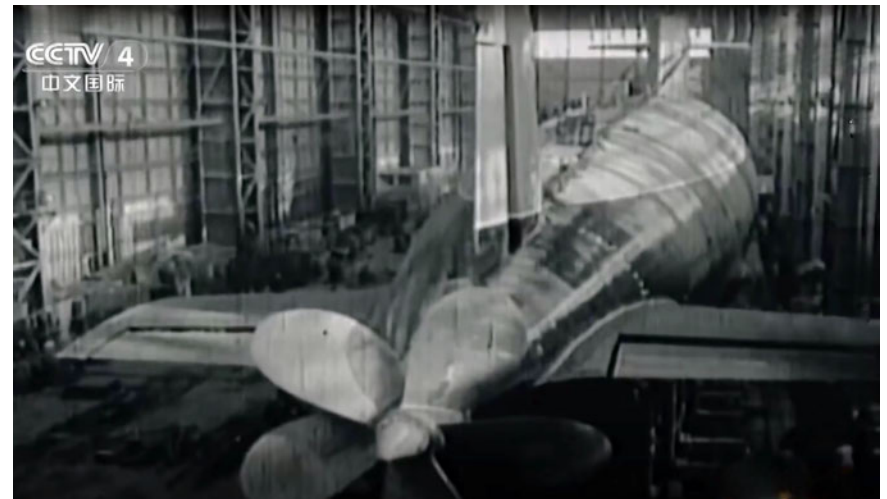
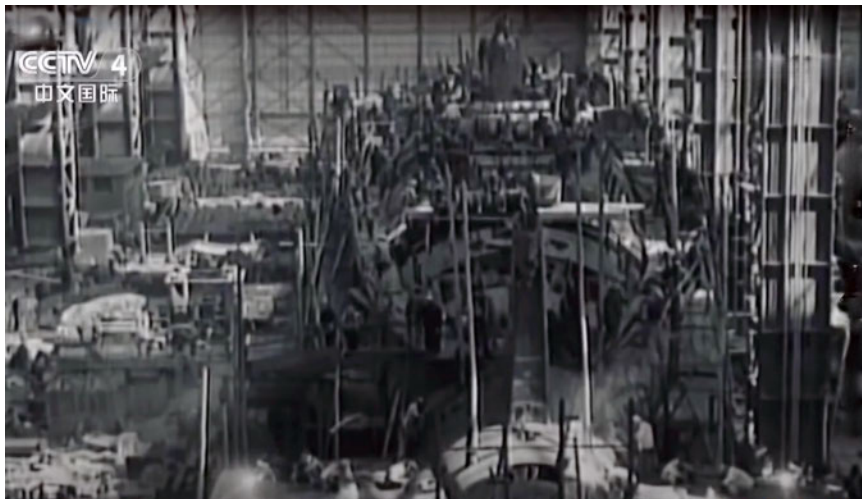



Type 09I SSN



- ◆ First two hulls suffered numerous mechanical problems.
 - Not particularly useful boats. Received limited improvements.
- ◆ Remaining three hulls are ≈8 meters longer – extension aft of the sail.
 - Extra length reportedly for better nuclear safety and maintenance and habitability issues.
 - Moderately more powerful reactor (58 MW).
 - Would be updated with new sonar, ASCM, anechoic coating, and seven-bladed propeller.
- ◆ Loud – comparable to Russian Project 627A November class SSN.
- ◆ Slow – maximum submerged speed of 24/25 knots.
- ◆ Limited military utility – some ASuW capability, limited self-defense ASW.
 - Described by Chinese as an “anti-submarine torpedo nuclear submarine.”



Type 09I SSN Tactical Snippets

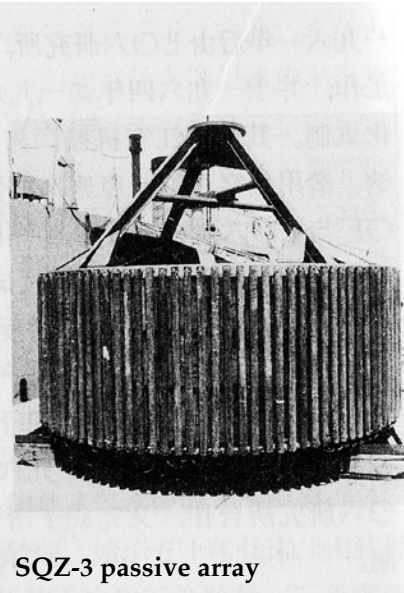
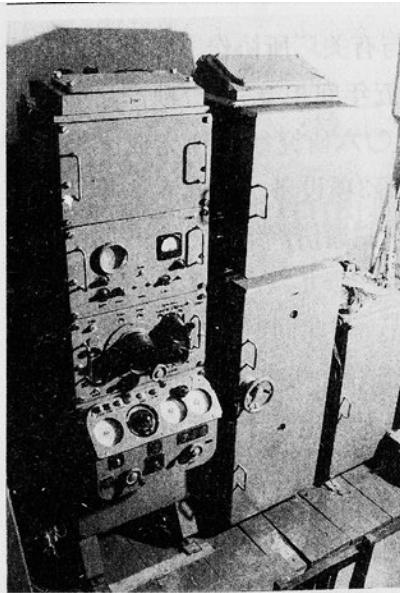

SQZ-3 passive array



First Yu-3 test firing in May 1988

- ◆ SQZ-3 integrated active/passive sonar.
 - Passive array essentially an enlarged version of the Soviet MG-10 Feniks [Trout Cheek].
 - “Integrated” in that the active and passive functions were controlled from the same console.
- ◆ Yu-3 torpedo was an indigenous Chinese design with significant differences from the Yu-1 and Yu-4 that were derived from Soviet torpedoes.
 - Length was much shorter than Soviet torpedoes as the Type 09I had shorter torpedo tubes designed to support launching weapons down to 300 meters.
 - Extremely long development left Type 09I and 09II submarines without torpedoes until 1989.



Type 09II SSBN



- ◆ Single unit, also suffered from mechanical difficulties.
- ◆ Loud – comparable to Russian Project 627A November class SSN.
- ◆ Slow – maximum submerged speed of 22 knots.
- ◆ Until 1989 lacked torpedo armament.
- ◆ Operational status of Type 09II and JL-1 was considered “questionable.”
 - No evidence the submarine conducted a deterrent patrol.
- ◆ Limited military utility – regional strike only.
 - JL-1 SLBM very short ranged, 1,770 km (1,100 miles).



Type 09III SSN



- ◆ First two Type 09III were likely disappointing.
- ◆ Faster than Type 09I, but short of an estimated 30-knot speed goal.
 - Maximum submerged speed reportedly is 28 knots.
- ◆ Slightly quieter than the Type 09I.
 - Still relatively loud – comparable to Russian Project 671 Victor I class SSN.
 - Anechoic coating fitted on the outer hull after commissioning.
- ◆ Improved ASuW capability, but ASW capability was still lacking.
 - Better sonar systems and ASCMs than Type 09I.
 - Not fitted with a towed array.



Type 09III with Modified Sail

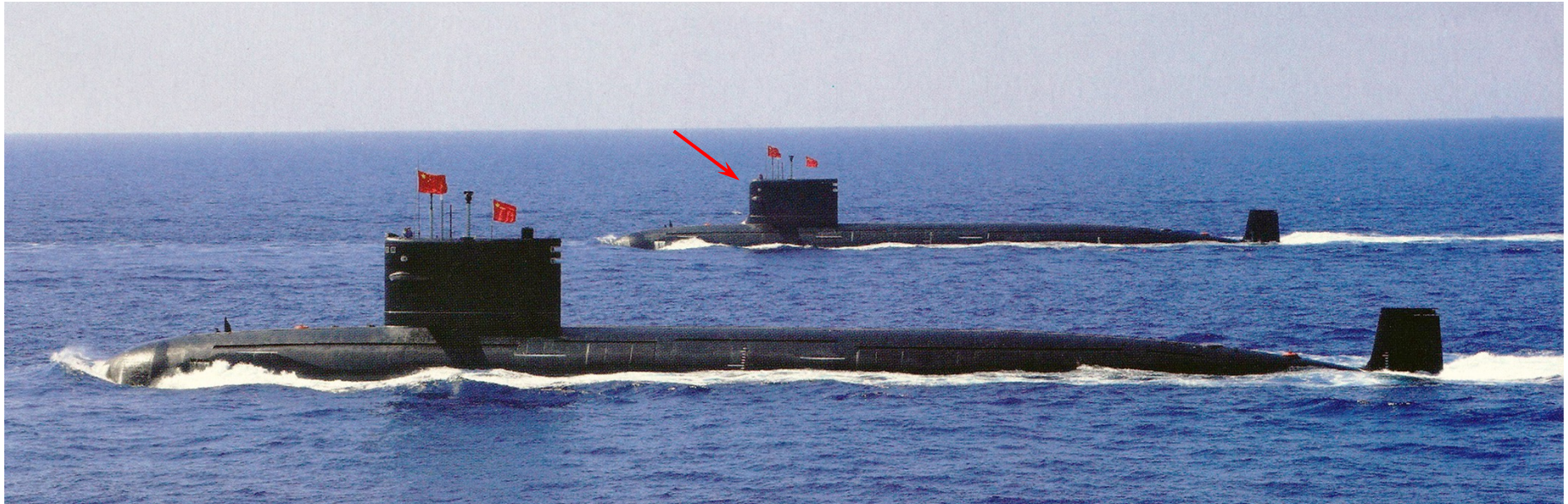

- ◆ One of the Type 09III hulls had minor modifications to the sail to reduce drag.
 - Small fillet or cusp at the base of the sail, rounded sail top.
- ◆ Changes made between mid-2013 and 2015.
 - First seen in June 2016.
- ◆ Sail drag possibly not reduced enough to reach estimated 30-knot goal.
 - Modifications made to only one unit.





Stealth is Everything

Artist's depiction of TYPE 093 SSN

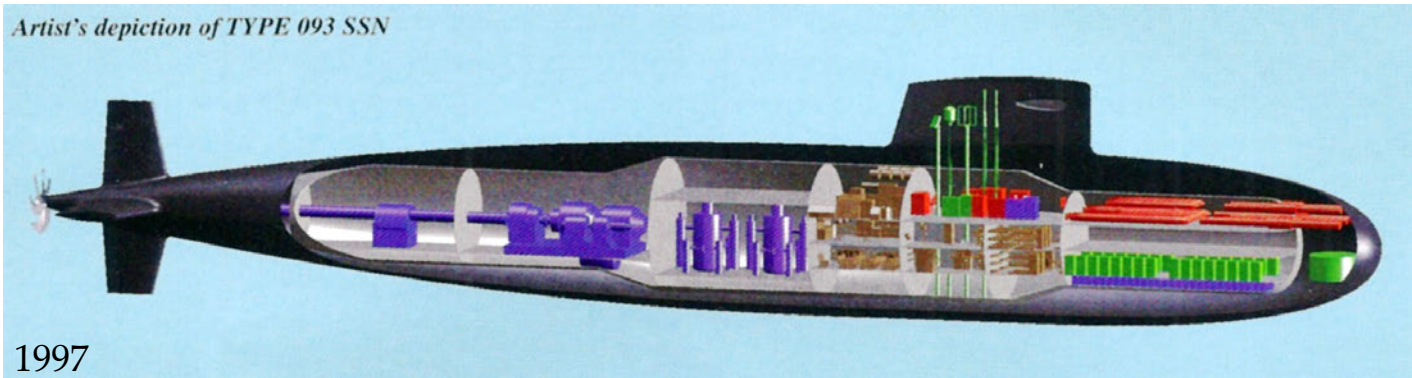

1997

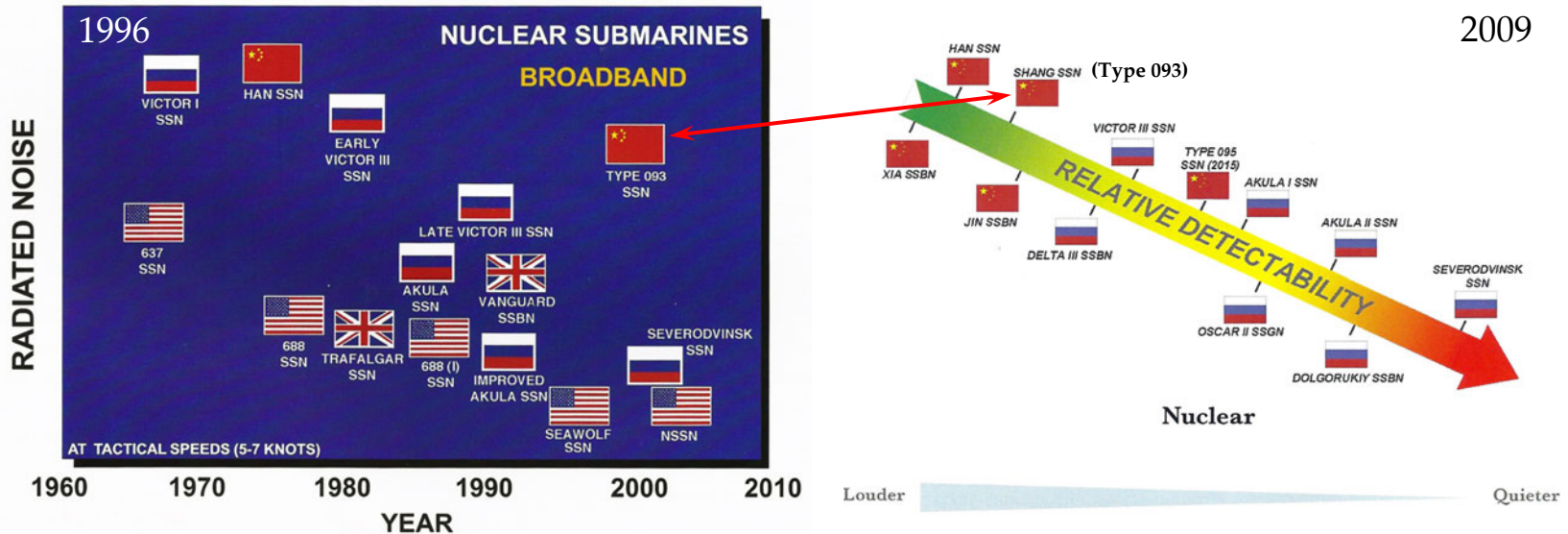

- ◆ ONI predicted the Type 09III to be comparable with Russian Victor III SSN.
 - Overall, a reasonably accurate estimate.
 - Acoustic signature estimate was initially a bit off – assumed significant Russian assistance.
 - 1996 was an engineering estimate, 2009 revision based on acquired data.



Type 09III Noise Reduction Measures

Single Isolation

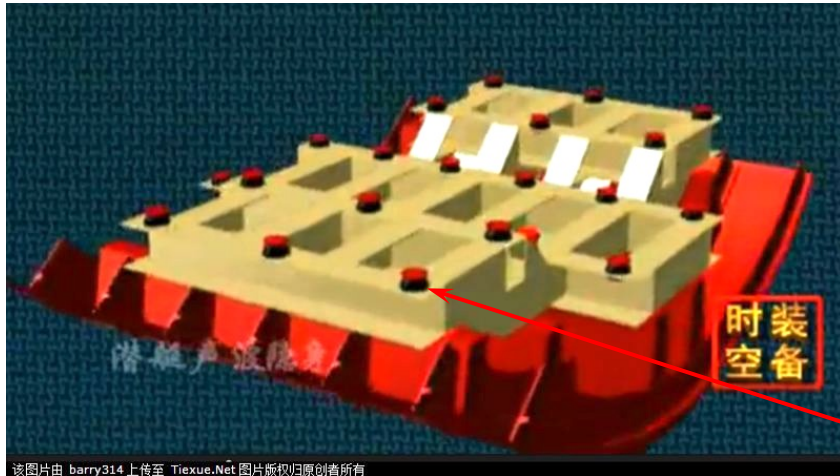

该图片由 barry314 上传至 Tiexue.Net 图片版权归原创作者所有

Double Isolation

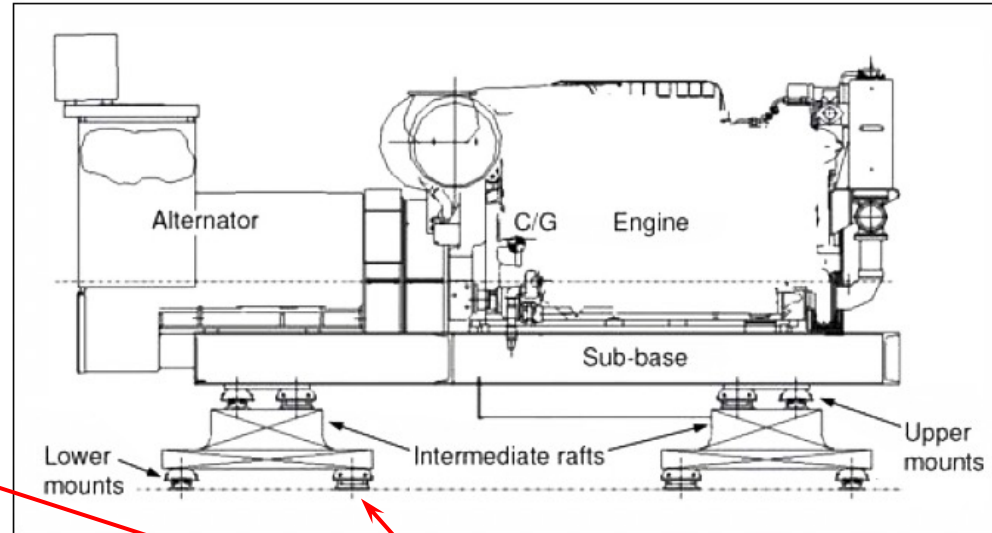

- ◆ The Type 09I used single level of isolation with rubber-metal sound mounts (BE series to the right).
 - When combined with high vibration levels of the propulsion plant machinery, this translates into very detectable narrowband tonals.
- ◆ The early Type 09III very likely used double or compound isolation with two sets of rubber-metal sound mounts and a small intermediate mass in between.
 - Likely used with German MTU diesels for Type 039 in mid-1990s.
 - This is not the same thing as a floating raft on Western SSNs.



BE-series rubber-metal isolation mount



Type 09IIIA Version 1 & 2 SSNs



- ◆ Approximate 10-year gap from the roll out of the second Type 09III.
 - Type 09IV production occupied building ways.
- ◆ More robust sail modifications to reduce drag.
 - Larger fillet, more rounded sail top, sail lengthened by ≈ 2.5 meters.
 - Probably achieve estimated 30-knot speed goal.
- ◆ Quieter, but still noisy – comparable to Russian Project 671RT Victor II SSN.
- ◆ Fitted with a towed array deployment tube on the upper rudder.



Type 09III A off Senkaku Islands



- ◆ Version 2 SSN surfaced off the Senkaku/Diaoyu Islands on 12 January 2018.
- ◆ The submarine had been tracked since mid-morning on 10 January.
 - Japanese Maritime Defense Force destroyer and P-3C maritime patrol aircraft.
 - Estimated speed of 5-7 knots indicate the submarine was detected and tracked by passive narrowband sonar systems.



Type 09IIIA Noise Reduction Measures

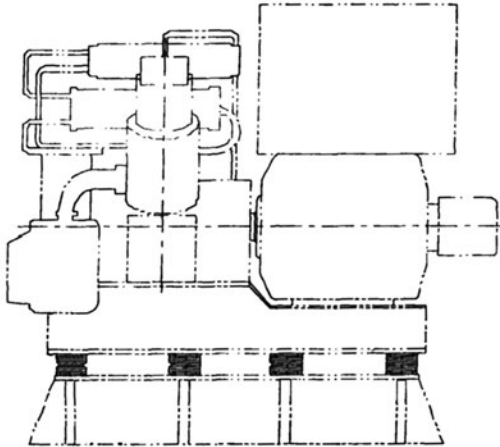

Single level isolation of a diesel engine with pneumatic mounts

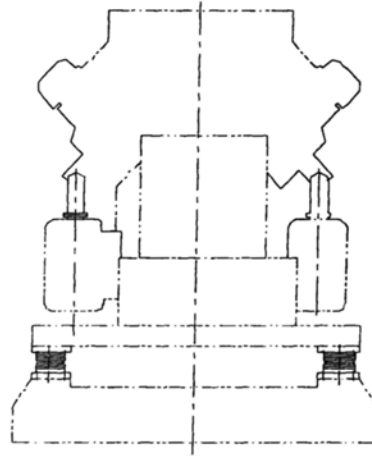

Chinese RKO type pneumatic (airbag) mount

- ◆ The early Type 09IIIA SSNs were laid down \approx 2010-2011 and the new airbag isolation mounts would have been available.
 - Probably already used on board Type 09IV hulls 3 and 4.
- ◆ Reversed engineered Russian pneumatic isolation mounts – RKO type.
 - Improvement part of the Project 636 Kilo class SS purchase.
 - China received the first two of ten submarines in 1997-98.
 - “Imitative Innovation” likely had indigenous variants available by \approx 2004.
- ◆ Pneumatic mounts are taller than rubber metal mounts and would very likely force the adoption of a single level of isolation.



Shaft Alignment – A Cruel Mistress

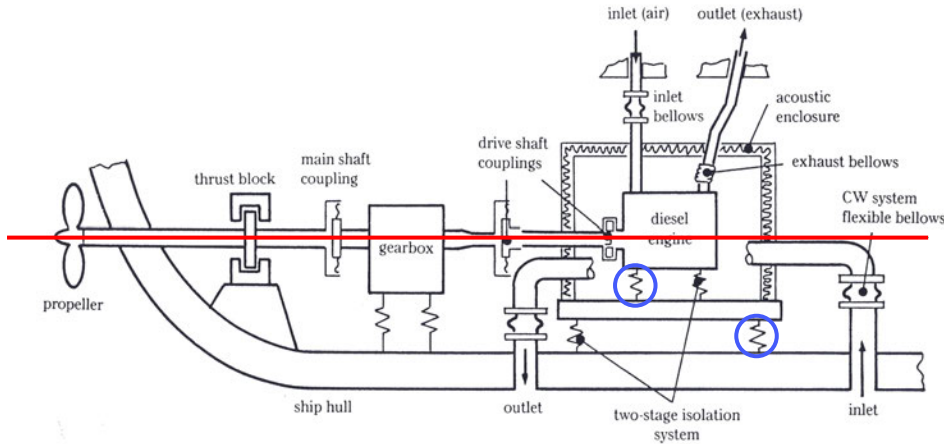

Surface ship propulsion train

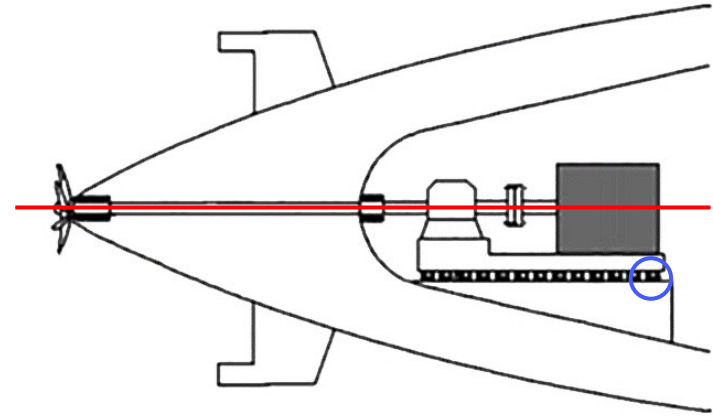

Submarine propulsion train

- ◆ The height of a propulsion train is limited if the shaft alignment of an existing plant design is to be maintained.
 - Altering the height of the propulsion train would require a major redesign.
 - This is particularly true of tear drop shaped submarine hulls where the shaft is aligned with the submarine's centerline.
- ◆ Chinese BE type sound mounts are about 3 inches ($\approx 76\text{mm}$) in height while early pneumatic mounts vary between 4.3 to 7.1 inches (110 - 180mm).
- ◆ Single level isolation would be necessary to maintain shaft alignment.
 - It's possible the intermediate mass would have to be reduced or eliminated entirely.



PLAN Submarine Towed Array



Type 09IV SSBN stern tube



Type 09III A SSN stern tube

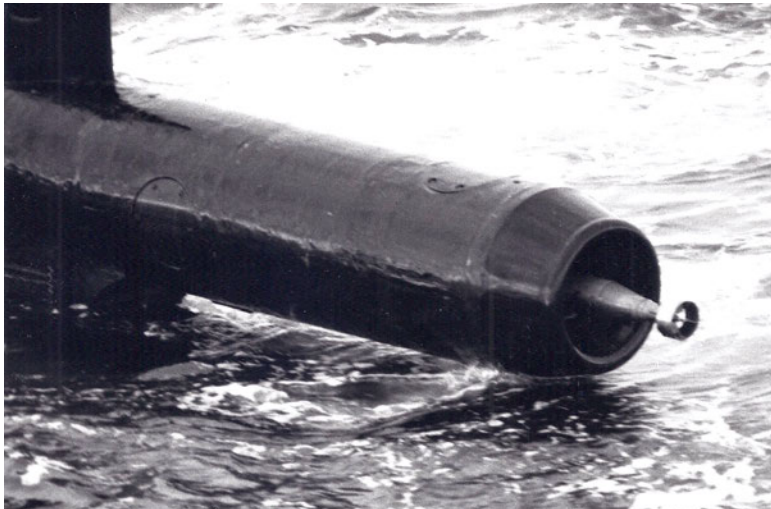

Project 667BDR SSBN towed array with drogue

- ◆ Likely derived from Russian submarine towed array designs.
 - Thin line: 40 mm in diameter.
 - Large aperture: 350 m total length.
- ◆ Towed array handling gear located behind the sail on Type 09III A SSNs.
 - Not a vertical launching system.
- ◆ Significant improvement in passive search capability.
 - Very low frequency narrowband; necessary for effective ASW.



Type 09IIIA Version 3 SSN



- ◆ Final Type 09IIIA design with two hulls built.
- ◆ Same sail modifications as Shang II Versions 1 and 2.
 - Probably achieved estimated 30-knot speed goal.
- ◆ Fitted with a towed array deployment tube on the upper rudder.
 - Bulge aft of sail more streamlined than that on the Version 2 submarine.
- ◆ Quiet – comparable to a Project 671RTM Victor III SSN.
 - Likely still uses single level isolation but incorporates the more advanced JYQN mounts.
 - First quiet submarine in PLAN.



Type 09IIIA Noise Reduction Measures



JYQN Chinese derivative of Russian APRK pneumatic mount.

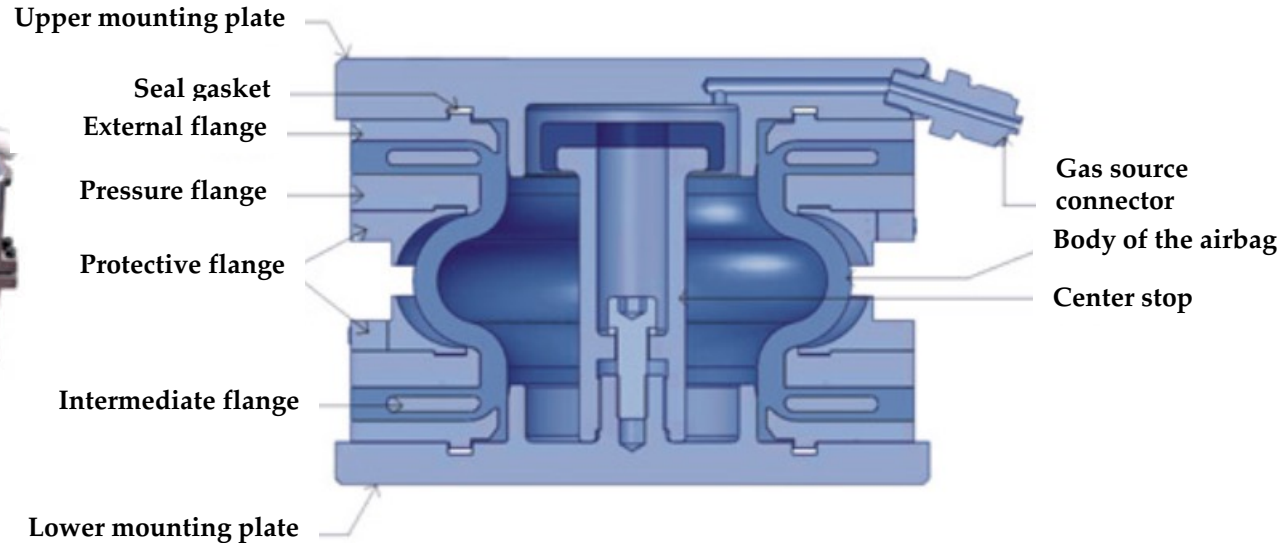

- ◆ The JYQN is described as an “intelligent airbag vibration isolator” and is derived from the Russian APRKu mount.
 - The APRKu is used on third-generation Russian submarines of the Project 971 Akula SSN series and the Project 949A Oscar II SSGN.
- ◆ APRKu pneumatic mounts likely purchased in 2002-2003.
 - Part of the multibillion-dollar purchase of Russian naval hardware and expertise by China.
 - Include the two Project 956EM Sovremenny II DDG and eight Project 636M Kilo SS.
- ◆ Indigenous Chinese designs available by about 2010 (Imitative Innovation).
- ◆ Would force single level isolation – mounts are about 8 inches (203 mm) in height.



Type 09IIIB SSN



- ◆ Two units rolled out thus far: 4 May 2022 and 11 January 2023 (imagery dates).
- ◆ Just slightly longer than other Type 09III submarines; additional ≈ 1.5 meters.
- ◆ Likely fitted with a pump jet propulsor.
- ◆ Potentially quieter than Type 09IIIA.
 - Due to reduced machinery vibration levels and use of JYQN pneumatic mounts.
 - Closer to original ONI 1996 estimate; Quiet - comparable to Project 945 Sierra I SSN.
 - Further reductions limited by pressure hull diameter – max of 9 meters.



Type 09IV SSBN



- ◆ Evolution of the units in the class matches the Type 09III SSN.
- ◆ Fillet and rounded top modifications made to the sail on the last four units.
- ◆ Twelve JL-2 missiles give PLAN a long-range strike capability.
 - JL-2 range is listed as 7,500 – 8,000 km (4,660 – 4,971 miles).
 - Missile is about the same size as a Trident II D5 SLBM.
 - 8 March 2023 STRATCOM: JL-3 backfit had begun. Range of 10,000+ km (6,210+ miles).
- ◆ First submarine class fitted with a towed array tube on the upper rudder.
 - Array handling gear aft of the missile tubes.
- ◆ Acoustic signature comparisons:
 - Hulls 1 & 2: Loud – Project 671 Victor I SSN
 - Hulls 3 & 4: Noisy – Project 671RT Victor II SSN
 - Hulls 5 & 6: Quiet – Project 671RTM Victor III SSN



Type 09III/09IV Hull Volume Limitations

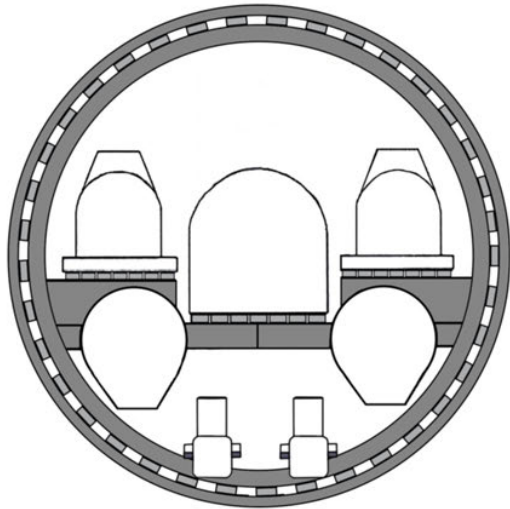

Project 671RTM Victor III ring or cage raft

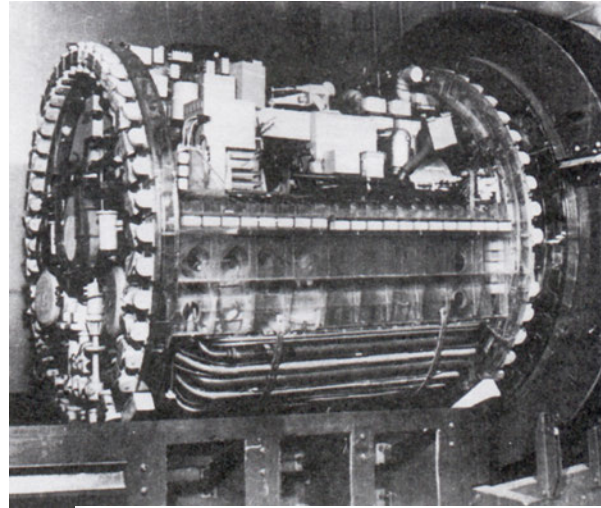

Project 705 Alfa ring raft

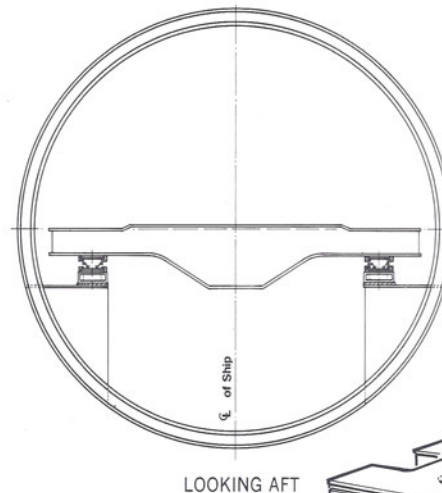

British SSN
Horizontal Floating Raft
(Friedman)

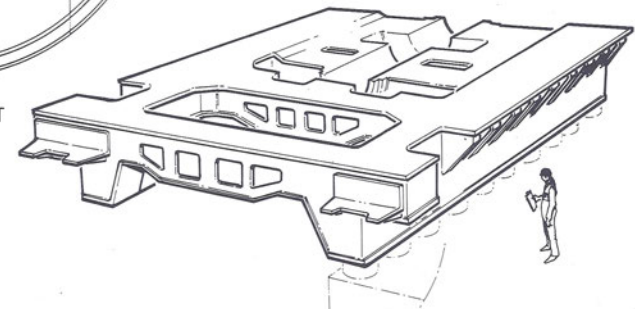

- ◆ Passive sound isolation is all about volume, volume, volume.
- ◆ Type 09III pressure hull diameter is too small for a Western large floating raft.
 - Type 09IV has similar limitations.
- ◆ No evidence of a Russian ring or cage raft in Chinese literature.
 - Tends to confirm individual component double isolation on early Type 09III/09IV.



Russian Third Generation Submarine Raft

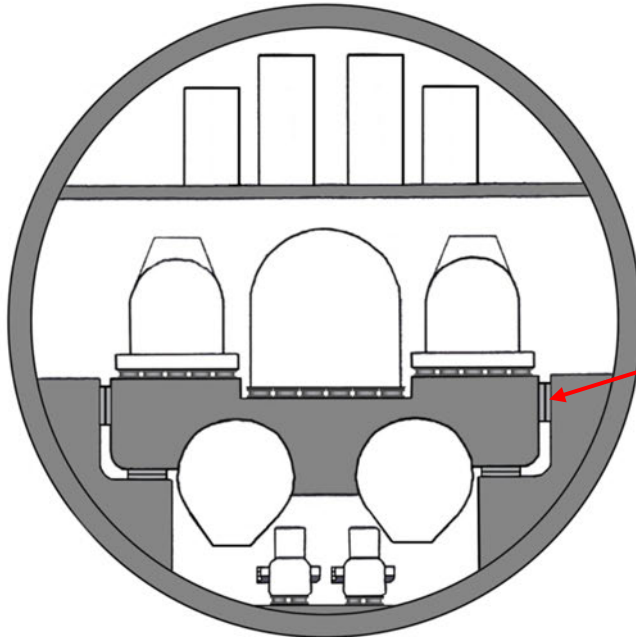

Project 971 Floating Raft

- ◆ The Project 971 Akula class has a maximum pressure hull diameter of 10.9 meters.
- ◆ If Akula-like noise levels, or lower, is the goal and the sound isolation features being used is derived from Russian technology – *Requires an Akula-sized pressure hull.*



Large APRK pneumatic absorber with rubber-cord sheath

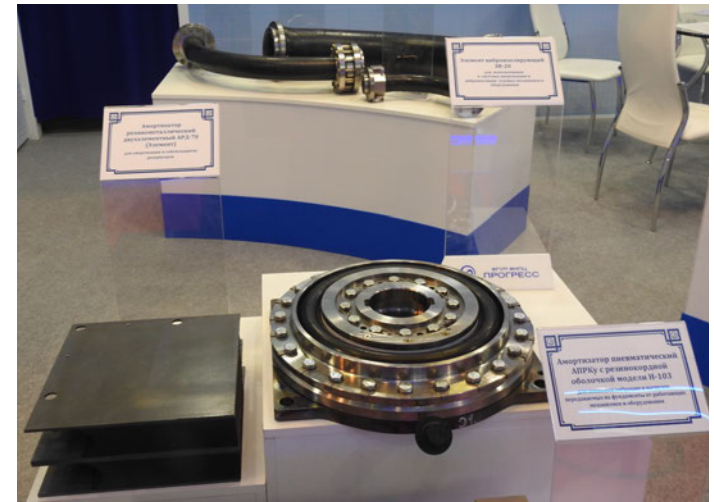

Progress display booth at IMDS 2017



Vertical Launch System



Universal VLS hatches on Type 055 Renhai class CG/DDG



VLS hatches on Type 032 Qing class SSB

- ◆ Type 032 hatches slightly larger than those on Type 052D and Type 055 surface ship universal VLS.
 - Max launch canister size: 9.0 meters in length, 0.85 meters in diameter.
 - Much larger than the Mk45 Mod 1 VLS Tomahawk canister on U.S. SSNs (6.3 m x 0.53 m).
- ◆ Payload is expected to be DH-10 LACM, YJ-18A ASCM and possibly the anti-ship ballistic missile tested from a Type 055 (April 2022 video).
 - Note: YJ-18A has a launch canister that fits in existing submarine torpedo tubes, VLS not necessary for submarines.



Vertical Launch System



图3 仿真模型

Fig. 3 Simulation model



图1 连接结构

Fig. 1 Connection structure

Ship Science and Technology (Vol. 38, No. 2, Feb. 2016)

- ◆ There are a number of articles, artist's impressions, and models that suggest more than two rows of tubes on the next generation of nuclear submarines.
- ◆ Type 032 with a 2×2 VLS configuration has a maximum beam of 10 meters, this gives a pressure hull diameter of 8 - 9 meters.
- ◆ Three tubes across will require a larger pressure hull diameter than that found on the Type 09III.

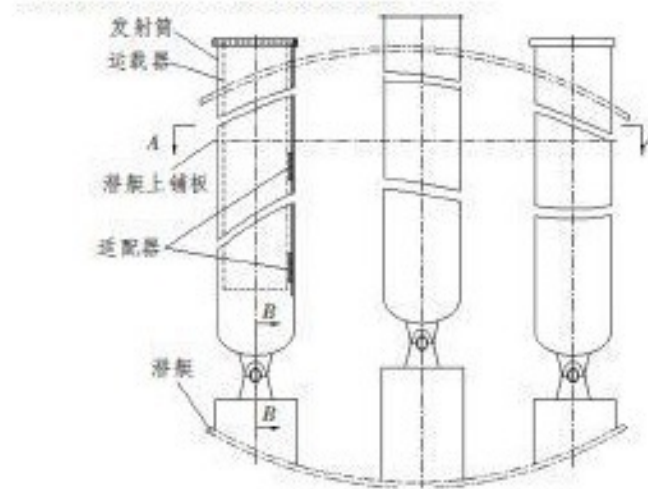

Estimated Reactor

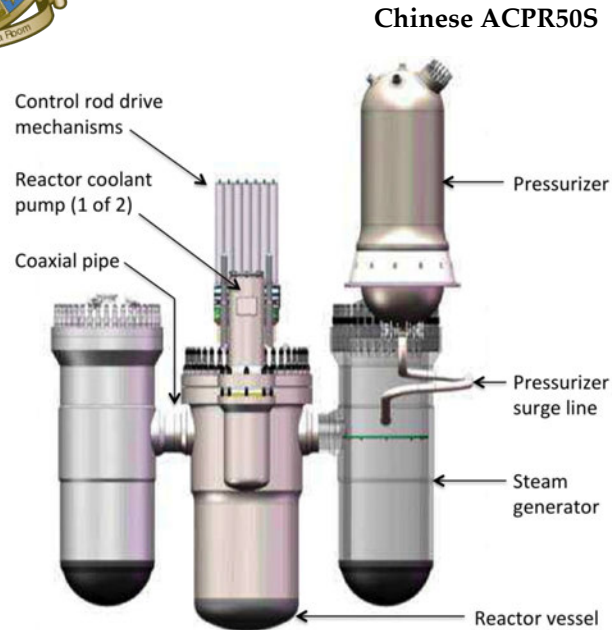

- ◆ Next generation Chinese marine reactors are derived from Russian designs.
- ◆ ACPR50S is based on the KLT-40S.
 - Block design. Unique “pipe inside a pipe” main coolant piping configuration.
 - Maximum power rating of 200 MW (thermal).
 - However, lots of online talk of a reactor with natural circulation capability.
 - KLT-40S is a forced circulation reactor design – so is ACPR50S.
- ◆ Project 971 Akula reactor, the OK-650B, is in the same family as the KLT-40S.
 - OK-650B can support natural circulation operation up to 30% max reactor power.
 - Smallest maximum pressure hull diameter this reactor has been fitted in to is 9.7 meters.



OK-650B Reactor

KLT-40S Reactor

OK-650B Reactor

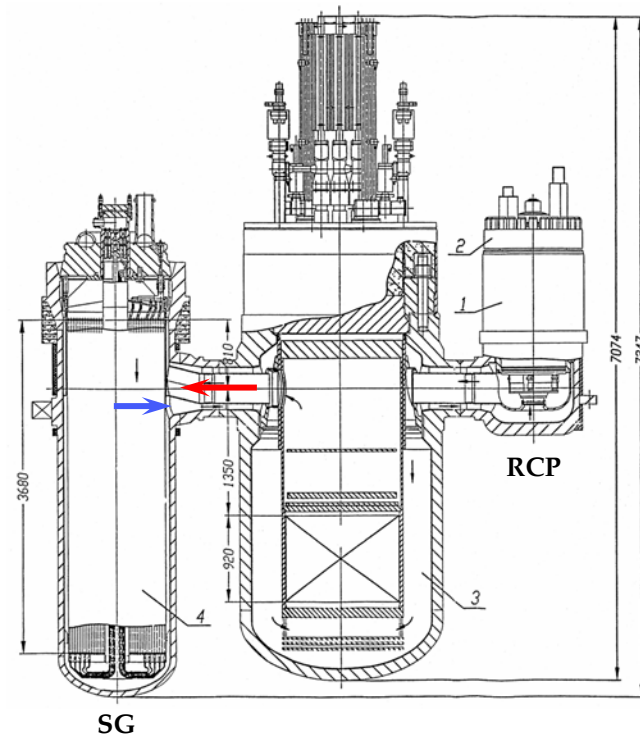

- ◆ OK-650B is a little larger than KLT-40S; best guess is about 7.5 meters tall.
- ◆ Maximum rated power is 190 MW (thermal).
- ◆ Red lines indicate where the coolant flow enters the steam generator.
 - The KLT-40S main coolant piping connects to the steam generator up high, the OK-650B connection is in the lower third of the steam generator. Block design has minimal piping drag.



A Hint

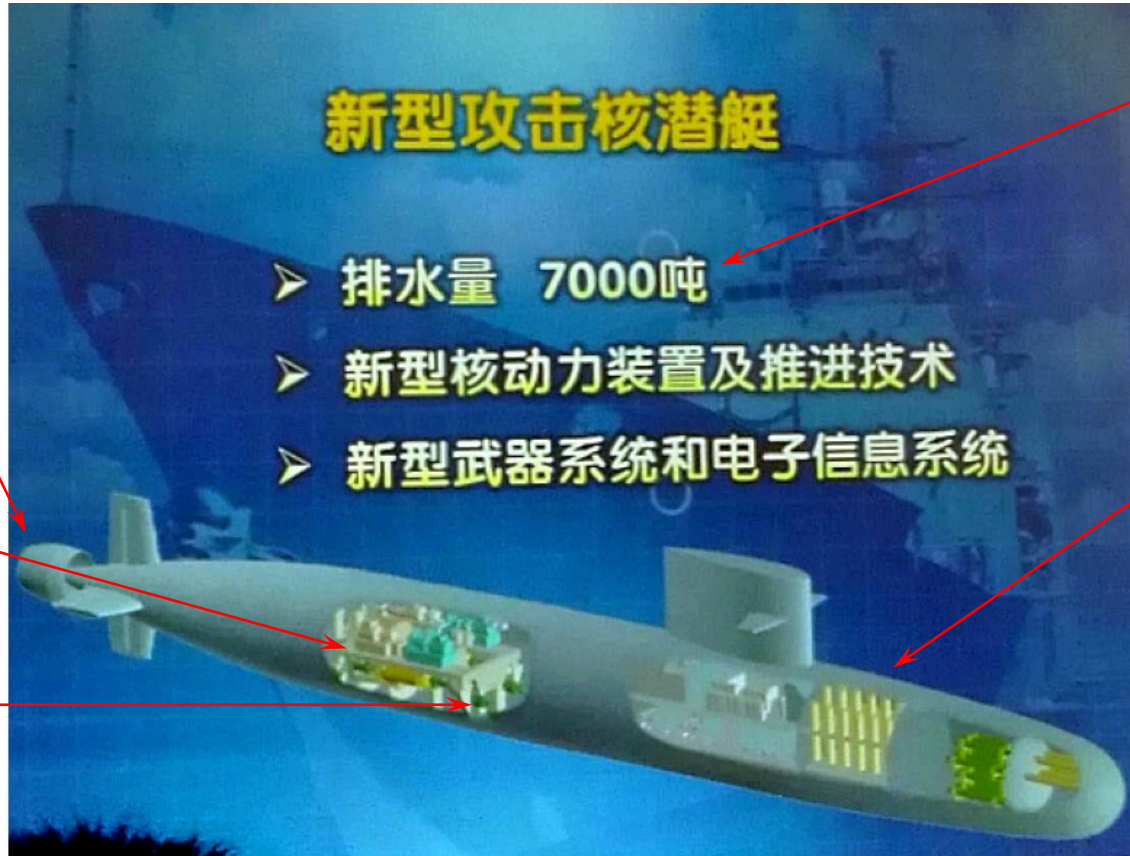

Pump jet propulsor

Large horizontal free floating raft

Objects appear to be large airbag isolation mounts

Displacement appears too small to be submerged displacement

Dedicated vertical launch system

- ◆ During the summer of 2017, RADM Zhao Dengping showed a slide that depicted a possible future SSN design.
- ◆ Floating raft shown argues for a max pressure hull diameter larger than 9 meters.
- ◆ Displacement value is most likely surface displacement.
 - One third larger than the the Type 09III (surface displacement about 5,300 tons).



Preliminary Workups?



BSHIC Shipyard October 2022



BSHIC Shipyard December 2022

- ◆ Production line workups may have been seen in late 2022.
- ◆ Cylindrical hull sections, without framing, have been seen in satellite imagery that are larger than those associated with the Type 09III or 09IV.
 - One has what looks like two cylinders running through it, probable missile tubes.
- ◆ Design assessment for the Type 09V/09VI begins with an Akula-size hull.



Type 09V Estimated Base Design

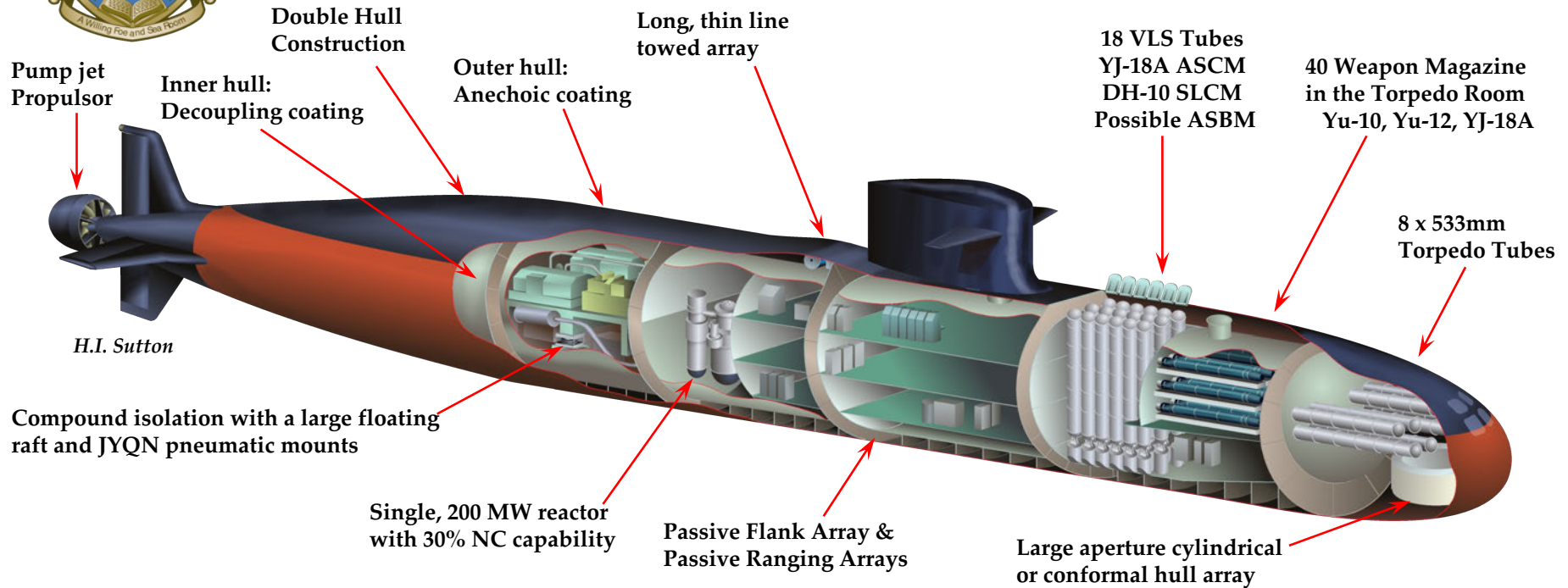

Length Overall: 115 meters

Surf Displacement: 8,500 tons

Subm Displacement: 10,700 tons

Main Propulsion Plant: \approx 45,000 HP

Acoustic Signature: Depends on propulsion plant

Beam: 13 meters

Pressure Hull Diameter: 11 meters

Reserve Buoyancy: 26%

Max Speed: 31 - 32 knots

- If turbo-reduction: Very Quiet – comparable to Project 971 Akula I SSN
- If hybrid electrical: Very Quiet – comparable to Project 971U Improved Akula I SSN



Type 09VI Estimated Base Design

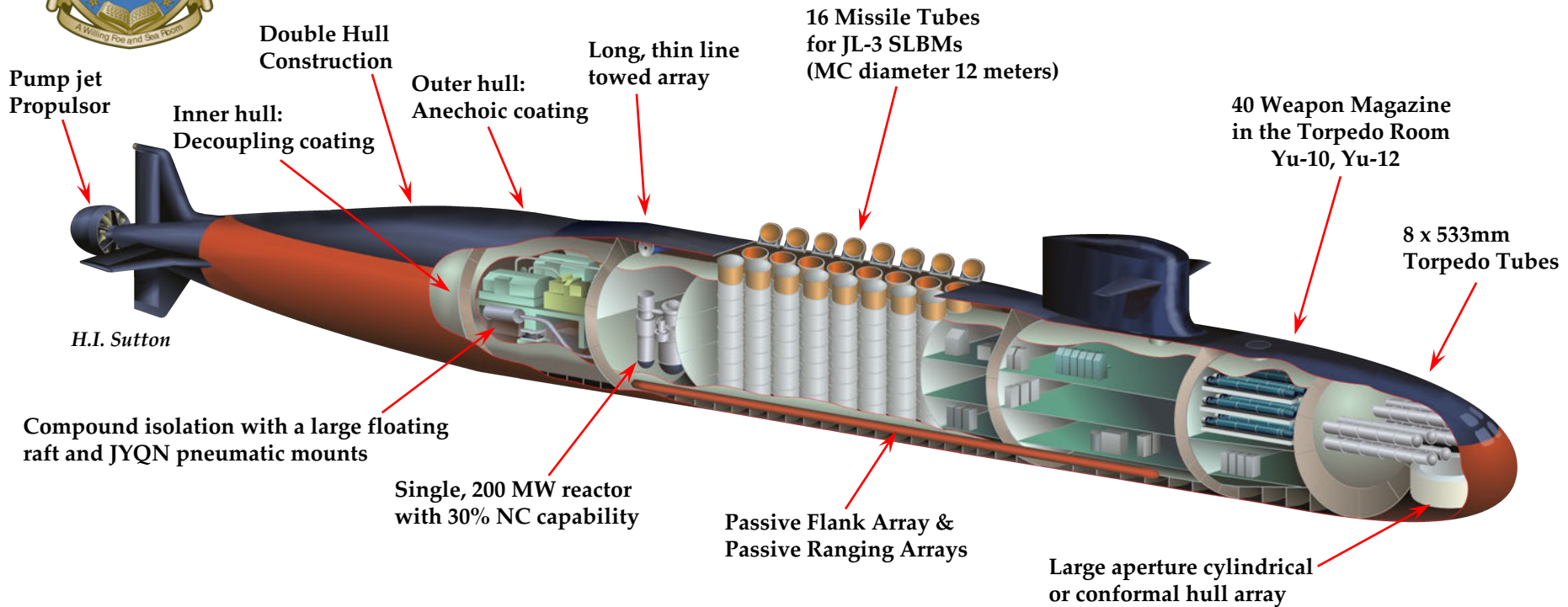

Length Overall: 150 meters

Surf Displacement: 12,500 tons

Subm Displacement: 15,750 tons

Main Propulsion Plant: \approx 45,000 HP

Acoustic Signature: Depends on propulsion plant

- If turbo-reduction: Very Quiet – comparable to Project 971 Akula I SSN

- If hybrid electrical: Very Quiet – comparable to Project 971U Improved Akula I SSN

Beam: 13.5 meters

Pressure Hull Diameter: 11 meters

Reserve Buoyancy: 26%

Max Speed: 27 - 28 knots



Revised Quieting Trend

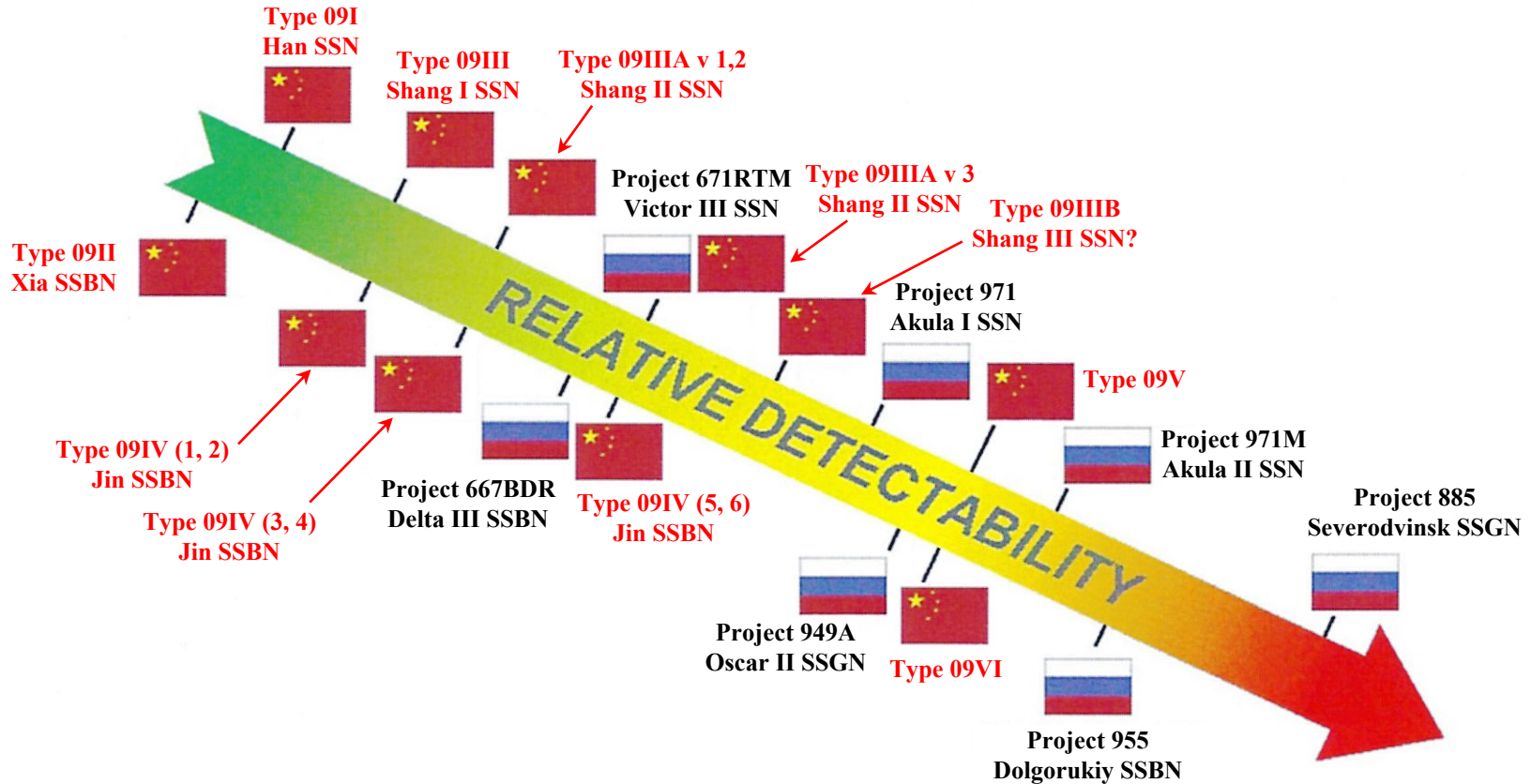

Louder

Quieter



Conclusions

We will have to build nuclear submarines even if it takes us 10,000 years!

Mao Zedong, Oct 1959

- ◆ After being denied technical support by the Soviet Union, China proceeded on a path of self-reliance to design and build nuclear-powered submarines.
 - An ironic twist as Russia has supplied considerable support since 1996.
- ◆ China successfully produced functional submarines, but not effective ones.
- ◆ Through “Imitative Innovation,” China has modified proven Russian submarine technology in nuclear reactors, sound isolation mounts, towed arrays, and torpedoes to meet their needs.
- ◆ After nearly 50-years since the first Type 09I SSN was commissioned, China is now on the verge of producing world-class nuclear-powered submarines.
- ◆ The Type 09V has the potential to be China’s Improved Akula I class SSN.
- ◆ The Type 09VI has the potential to be China’s *Dolgorukiy* class SSBN.
 - Quieting level similar to the Improved Akula I class SSN.
- ◆ The implications for the U.S. and our Pacific allies will be profound.