



# *The Sinking of Moskva*

*Christopher Carlson*

*Historicon 2022*

*Admiralty Trilogy Seminar*





# Outline

- ◆ **On 13 April 2022, the cruiser *Moskva* was attacked by a Ukrainian coastal missile battery firing R-360 Neptune ASCMs.**
  - Sank on 14 April from progressive fire and flooding while under tow.
- ◆ **Look at the design of the Project 1164 Atlant [Slava] class cruiser.**
  - *Moskva* was nearly 40 years old; late 1970s era technology.
- ◆ **Examine the attack and why it was successful.**
  - Ukrainian R-360 Neptune missile system; address targeting options.
  - *Moskva*'s material condition, crew readiness.
- ◆ **Damage assessment.**
  - Primary damage (warhead) and secondary damage (fire and flooding).
  - Russian damage control philosophy and training.
- ◆ **Comparison of *Moskva* sinking with HMS *Sheffield*.**



# Project 1164 Atlant Cruiser

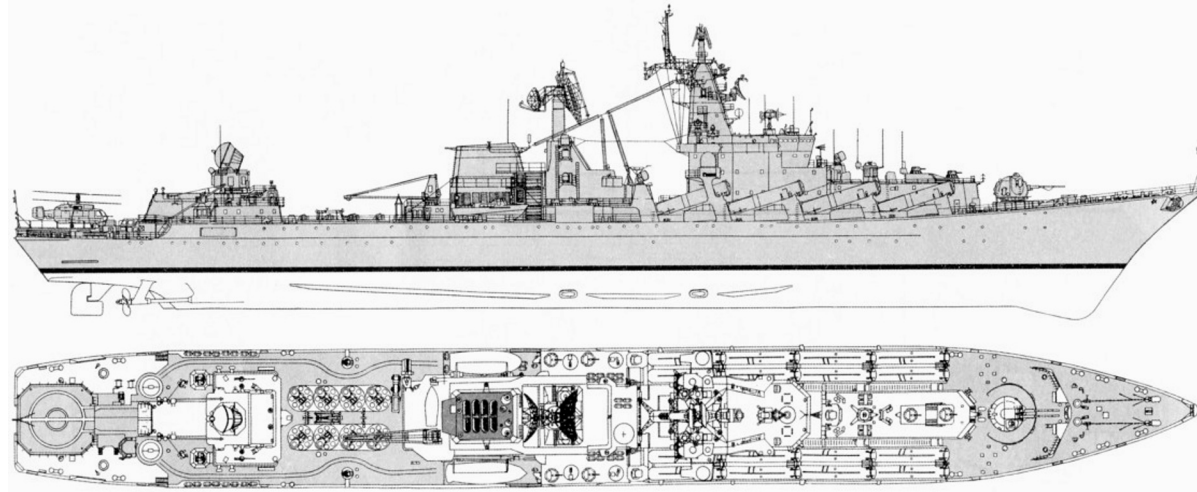

- ◆ Design project approved by the Council of Ministers in April 1972.
- ◆ Tactical-Technical Requirements (TTZ) submitted in October 1972.
- ◆ Modified TTZ for draft design approved in December 1972.
- ◆ Technical design completed in August 1974.
  - Leningrad Central Design Bureau-35 (now Severnoe Design Bureau)
  - Lead designers: A.K Perkov, V.I. Mutihin
- ◆ Only three of the planned ten ships were completed.
- ◆ Lead ship, *Slava*, was laid down in November 1976 at Shipyard 445, 61 Kommunara Shipbuilding Plant, Nikolayev, Ukraine.
  - *Slava* was re-named *Moskva* on 15 May 1995.



# Project 1164 Atlant Cruiser

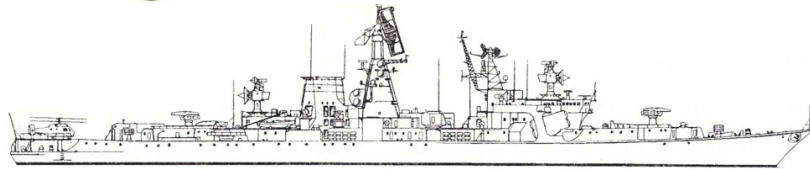

**Project 1134B**

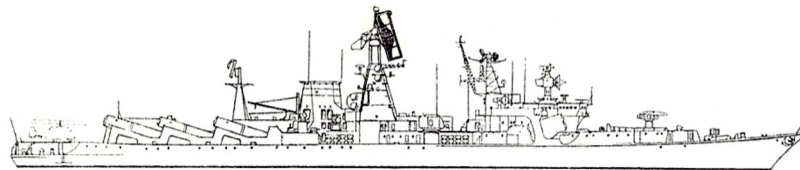

**Initial Design Concept**

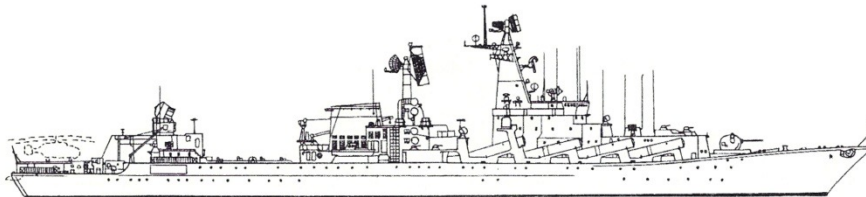

**Final Project 1164 Design**

**S-300F [SA-N-6] Test ship**

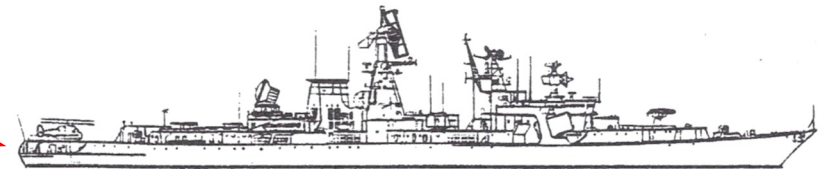

**Project 1134BF**

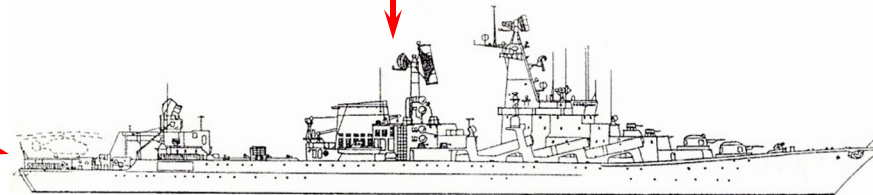

**Early Project 1164 Design**

- ◆ **Design basis was the Project 1134B [Kara] class cruiser.**
  - **Increased anti-surface capability with twelve P-500 Bazalt ASCMs.**
  - **Combined with the S-300F long-range air defense SAM system.**



# Project 1164 Atlant



## ◆ Ship characteristics:

- **Displacement:** 9,300 tons (standard), 11,280 tons (full load)
- **Dimensions:** 610ft/186.0m (length), 68.2ft/20.8m (beam)
- **Speed:** 18 knots (economic), 32 knots (maximum)



# Project 1164 Radars

**MR-710M Fregat-M [Top Steer]**



Provides support to the S-300F system.

**MR-800 Flag [Top Pair]**



Primary purpose is to provide situational awareness for formation air defense.





# Moskva - Air Defense Coordinator

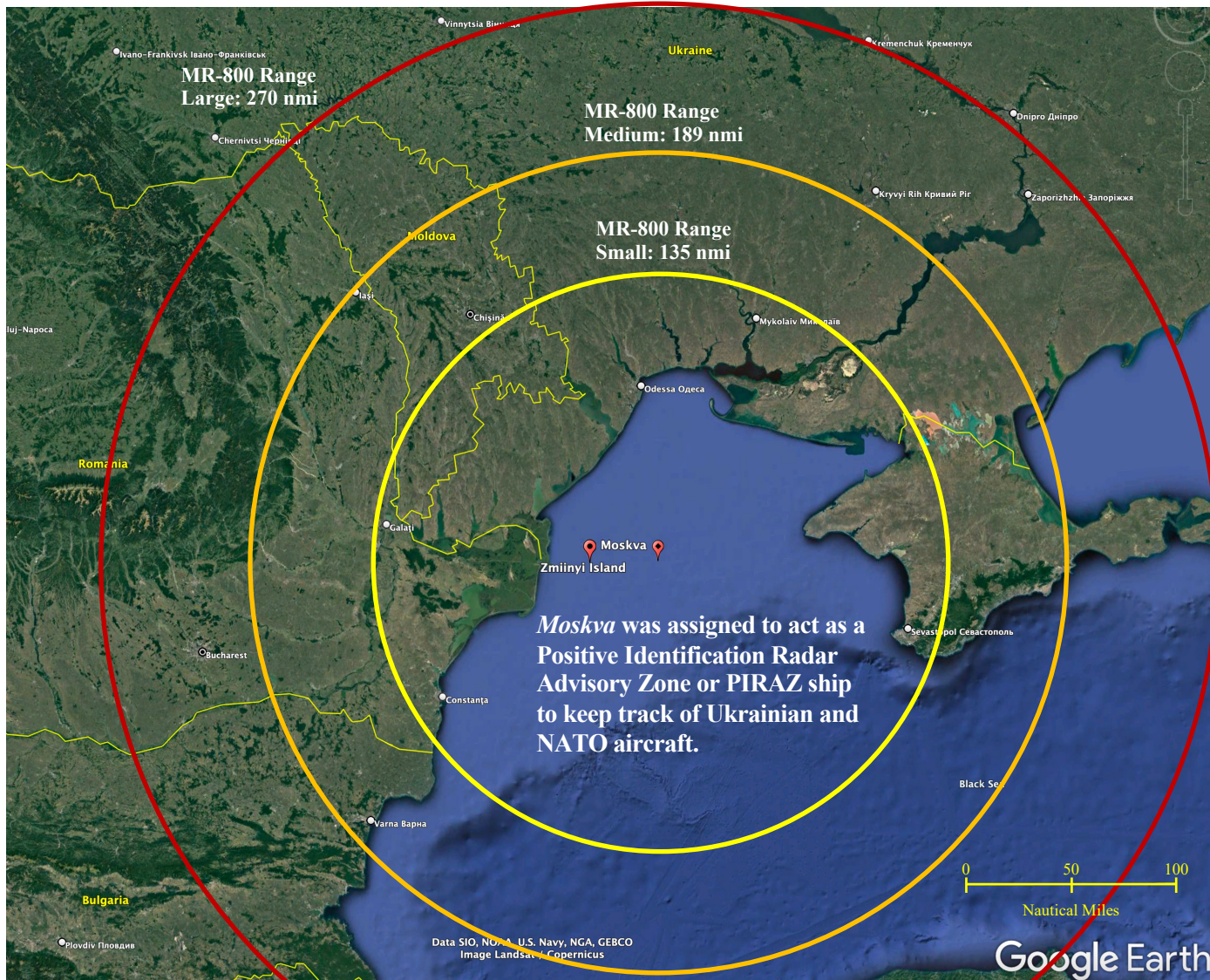



# Project 1164 Radars



- ◆ Each radar output displayed individually – PPI displays.
- ◆ Operator involved in detection and tracking – not automated.
  - Hybrid analog and solid-state digital components.
  - Manpower intensive.
    - Note the number of command/function buttons on the control console.





# Project 1164 Weapon Control Consoles

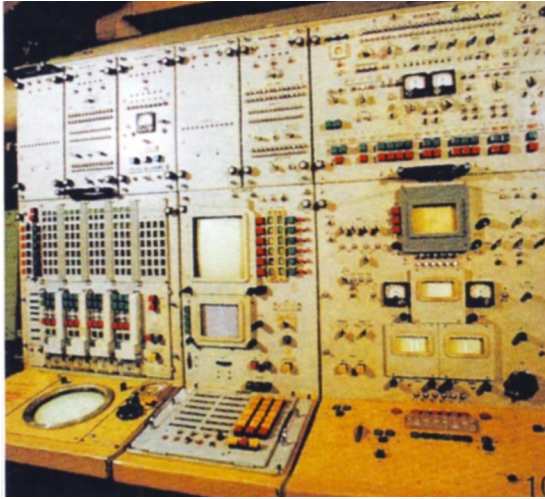

S-300F Console

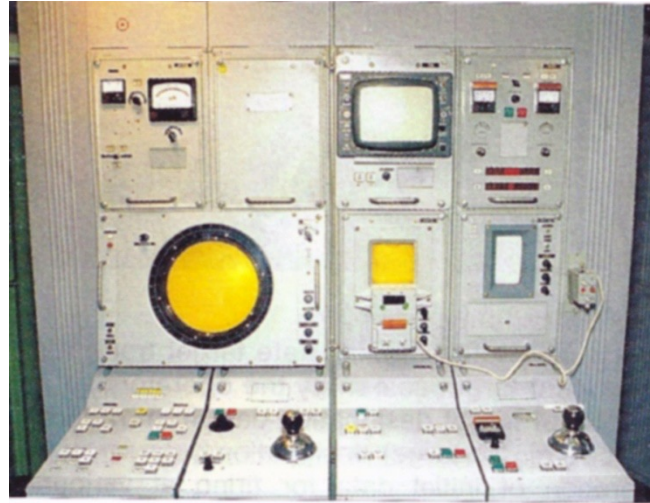

AK-130 Console

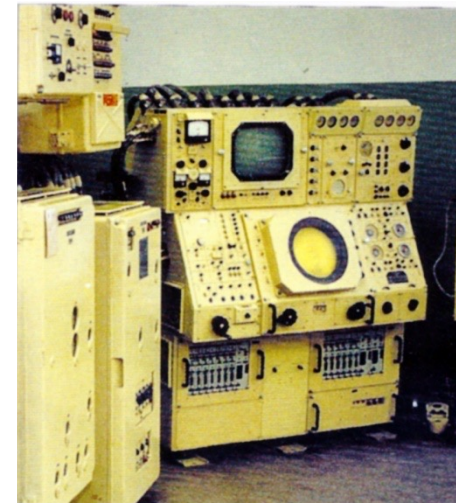

AK-630 Console

◆ **Lesorub-1164 (Lumberjack-1164) combat system feeds multiple individual weapon control consoles.**

- Described as automated, but operator(s) are heavily involved in allocating and executing fire, assessing combat results.
- Hybrid analog and solid-state digital components.
- Manpower intensive.
  - Weapon functions often performed by multiple individuals; S-300F console has three positions.



# Project 1164 Atlant Assessment



- ◆ When first commissioned in December 1982, *Slava* was a formidable ship with advanced anti-ship and anti-air systems...but:
- ◆ These systems required a large number of well-trained operators to work effectively.
- ◆ Reflects the Soviet state-of-the-art of 40+ years ago.
  - *Moskva* received very few weapon or sensor upgrades over her life.



# R-360 Neptune ASCM



- ◆ **Similar to the Russian Kh-35U, improved SS-N-25.**
- ◆ **Ukrainian defense product, State Kyiv Design Bureau “Luch”.**
- ◆ **Missile characteristics:**
  - **Range: 280 km/151 nmi**
  - **Speed: Mach 0.8**
  - **Warhead: 145 kg high explosive, semi-armor piercing**
  - **Cruise altitude: about 10 meters**
  - **Terminal altitude: about 3-4 meters**



# Neptune 360 MTs Rocket System



- ◆ **A coastal Neptune missile battery consists of:**
  - **Up to four launch vehicles with four R-360 missiles each.**
  - **One mobile command post.**
  - **One transport loading vehicle.**
  - **Up to four transport vehicles carrying missile reloads.**



# OTH Targeting Assets

Mineral-U



Bayraktar TB2



- ◆ **Ukraine had only two valid real time OTH targeting methods.**
  - **Mineral-U: a dedicated over the horizon targeting system.**
  - **Turkish Bayraktar TB2 unmanned aerial vehicles.**
- ◆ **Mineral-U active/passive coastal radar system.**
  - **Active range: up to 135 nmi, passive range: up to 324 nmi.**
    - **First tested in the Fall of 2021, probably not used.**
- ◆ **TB2 drone has an EO/IR sensor with a laser rangefinder and a data link with a range of 185 statute miles (about 161 nmi).**
  - **Reportedly used in the attack on *Moskva*.**



# Moskva Attack on 13 April 2022

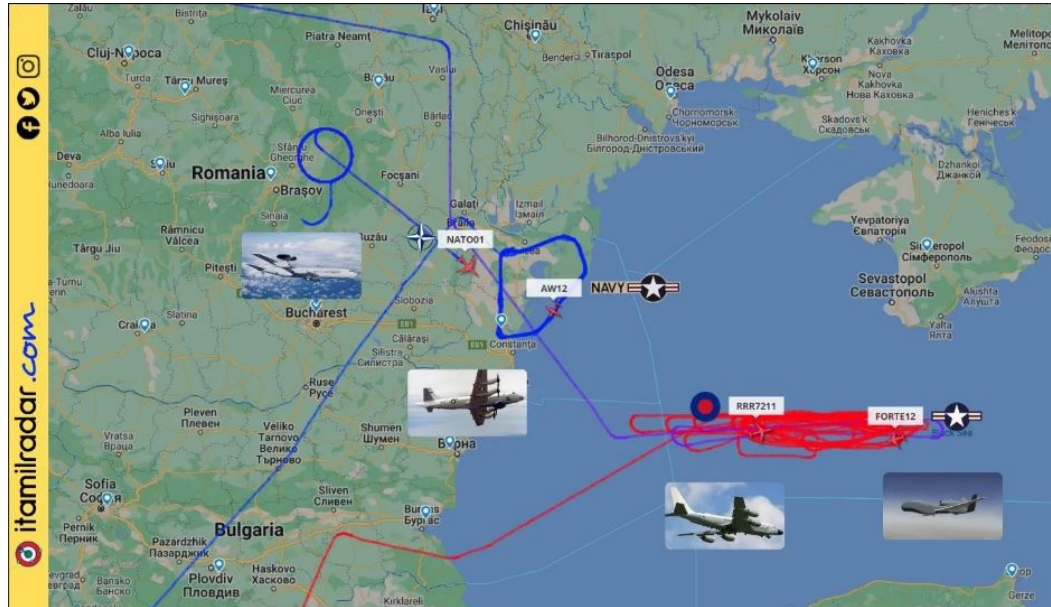

## Bayraktar TB2 drone

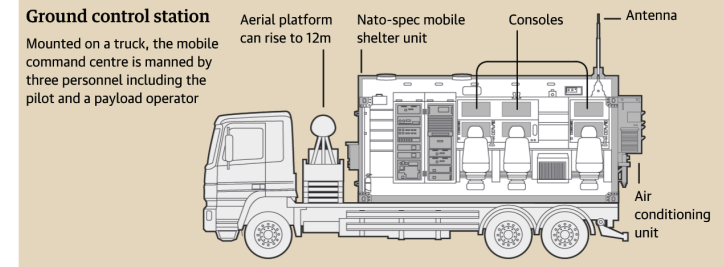
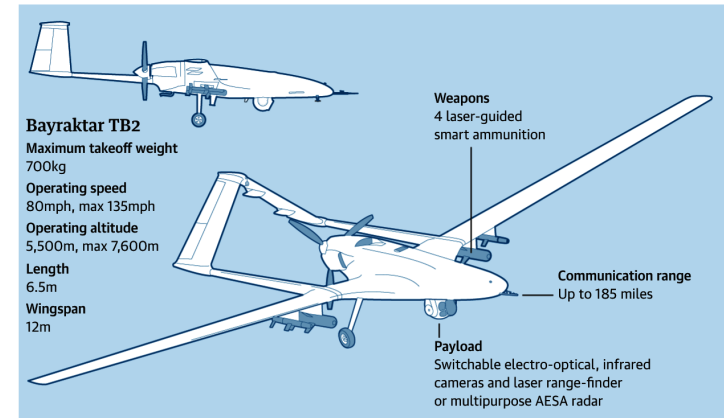

Guardian graphic. Source: Baykar Tech

- ◆ NATO aircraft (E-3, E-8C, P-8A, EP-3C, RC-135U/V/W, etc) and RQ-4B/D UAVs monitored Russian Black Sea Fleet movements.
- ◆ Provide cueing information to Ukrainians – told where to look.
  - Vectored a TB2 UAV to get visual contact, relay position in real time.
  - *Moskva* didn't vary its operating pattern all that much.



# Moskva Operating Pattern

Pr.1164 SLAVA Class Cruiser

## Moskva

Ukraine War Activity – Feb 24 to Apr 4 2022



2 x 20 x OSA-MA (SA-N-4 GECKO) short-range surface-to-air missiles

2 x 5 x 533mm heavyweight torpedo tubes

Helipad. 1 x Ka-27 HELIX helicopter

64 x S-300F Fort (SA-N-6 GRUMBLE) long-range surface-to-air missiles

2 x RBU-6000 anti-submarine Rockets

AK-630 anti-aircraft guns (6 total)

1 x twin AK-130 130mm/L70 dual purpose gun

16 x P-1000 Vulkan (SS-N-12 SANDBOX) supersonic anti-ship missiles

Observed Locations based on Analysis of Open source intelligence (OSINT)

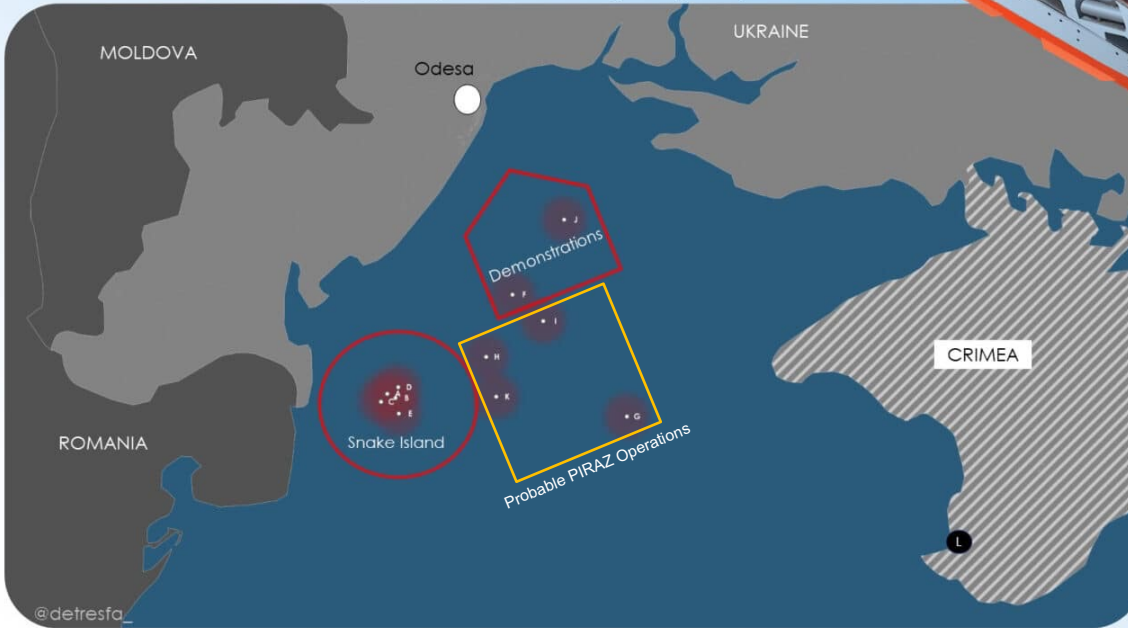

**Key**

- A Feb-24 2022
- B Feb-26 2022
- C Feb-28 2022
- D Mar-07 2022
- E Mar-08 2022
- F Mar-15 2022
- G Mar-15 2022
- H Mar-28 2022
- I Mar-30 2022
- J Apr-01 2022
- K Apr-04 2022
- L Sevastopol  
Mar-07 2022  
Mar-10 2022  
Mar-14 2022  
Mar-22 2022  
Mar-25 2022  
Mar-26 2022





# Moskva Operating Pattern



Radar Satellite Image Shows Location Of Russian Navy Cruiser Moskva On Apr13 2022

Sentinel-1 SAR (Synthetic Aperture Radar) Satellite Image, 15:52UTC

H I Sutton Twitter: @CovertShores, Website: www.hisutton.com



Candid photo of her leaving port on her final voyage

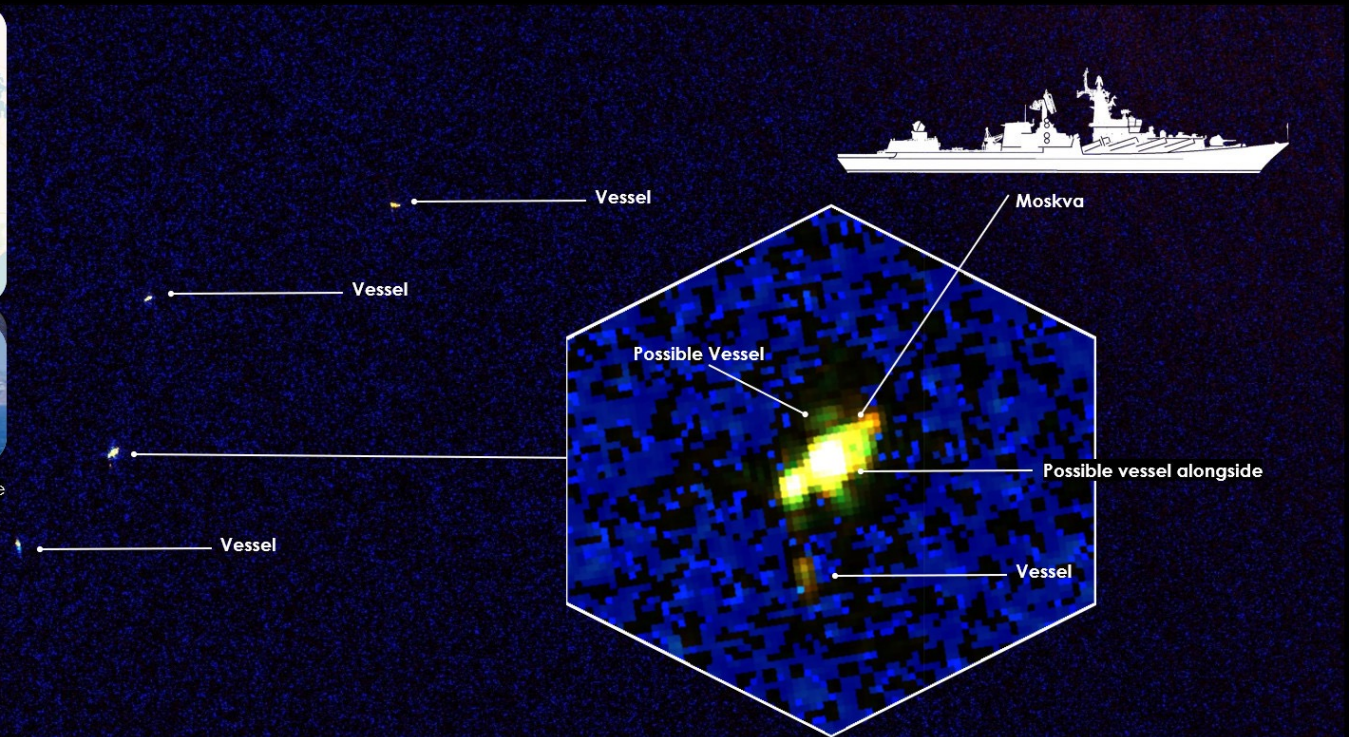

1 km

Credit: European Union, contains modified Copernicus Sentinel data 2022, processed with EO Browser

Copernicus sentinelhub





# Moskva Material Condition



СПРАВКА – ДОКЛАД  
по состоянию гркр «Москва»  
на 10 февраля 2022 года

- ◆ A 10 February 2022 readiness report briefly posted online for *Moskva* indicated issues with many ship systems, to include:
  - Four of six gas turbine generators needed repair; two were regulated to emergency use only due to significant wear.
  - S-300F Fort [SA-N-6] director had problems keeping the target illuminated.
  - Both Osa-MA [SA-N-4] directors either could not transmit or had issues when transmitting.
  - One of the AK-630 Gatling guns was hard down with a control unit malfunction.
  - All three MR-123 directors for the AK-630 guns had technical difficulties.
- ◆ All required representatives from the factory to correct the issue.



# Crew Training



- ◆ **Russian Navy relies heavily on conscripts to man their ships.**
  - *Moskva* reportedly had a crew of 534 of which 257 were conscripts.
- ◆ **Since 2021 the length of service had dropped to just one year.**
  - Limited, very basic training – insufficient by Western standards.
- ◆ **Navy wide funding constraints limited operational training.**
- ◆ **In all respects, *Moskva* was not properly prepared for combat.**



# ASCM Attack on 13 April

- ◆ On the evening of 13 April, a Ukrainian Neptune coastal missile battery fired at least two R-360 missiles at *Moskva*, most likely using targeting data provided by a TB2 drone.
  - More missiles could have been fired; TEL has four canisters.
  - No evidence to support more Neptune missiles being launched.
- ◆ Both missiles struck *Moskva* on the port side, amidships.





# *Moskva* SAM Directors



- ◆ **Photographic evidence strongly suggests *Moskva*'s surface-to-air missile systems were not ready for action.**
  - **Both the 3R41 Volna [Top Dome] and the 4R-33A/MPZ-301 Baza director/scanning radar combination [Pop Group] are trained aft in their typical stow position.**



# Moskva Defenses Theoretically Capable

S-300F [SA-N-6]



Osa-MA [SA-N-4]



◆ S-300F and Osa-MA SAMs have a minimum engagement altitude of 25 meters.

- S-300F can engage six targets, Osa-MA one.
- *Harpoon V* rates these as partial very low (PVLow) or semi-sea skimmer capable.

◆ Two AK-630 batteries could have engaged – designed to intercept sea skimming ASCMs.



AK-630



# Moskva Hit Locations

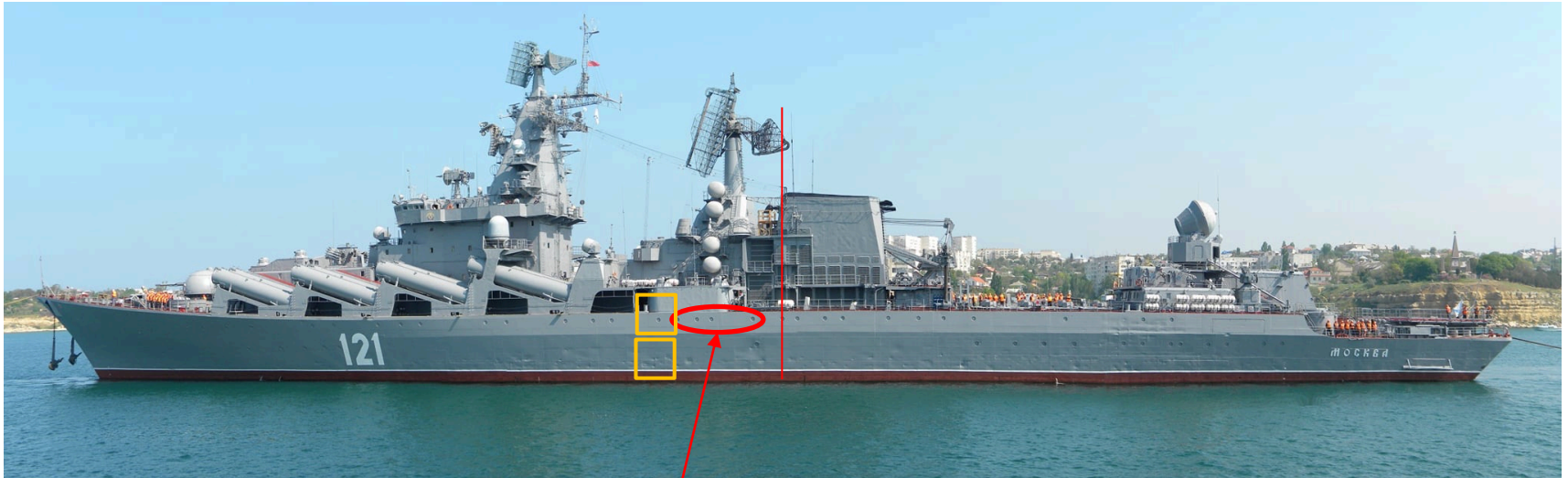



# Moskva Hit Locations

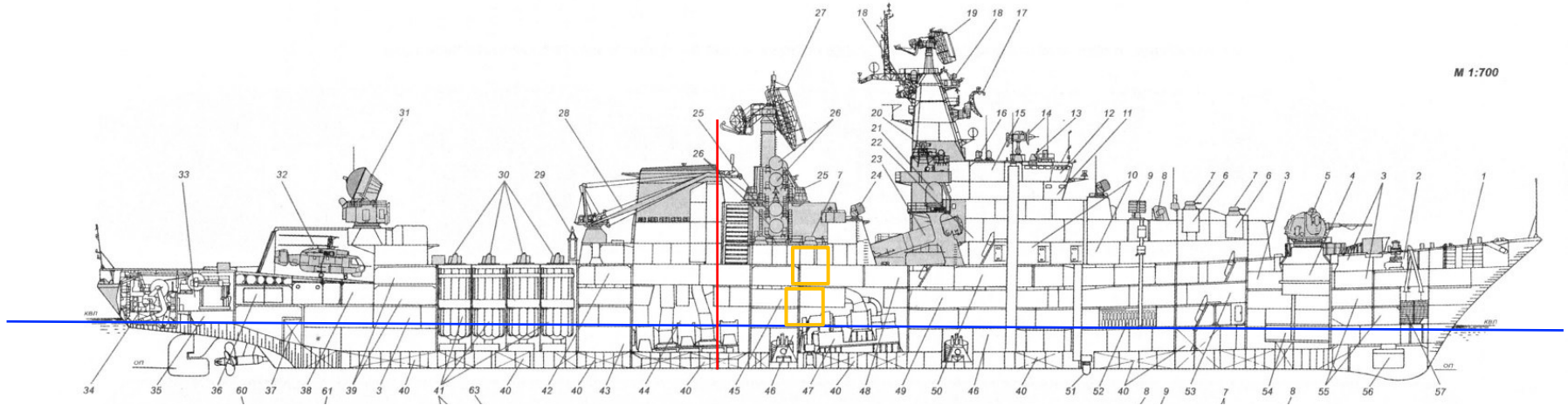



# *Moskva* Missile Damage

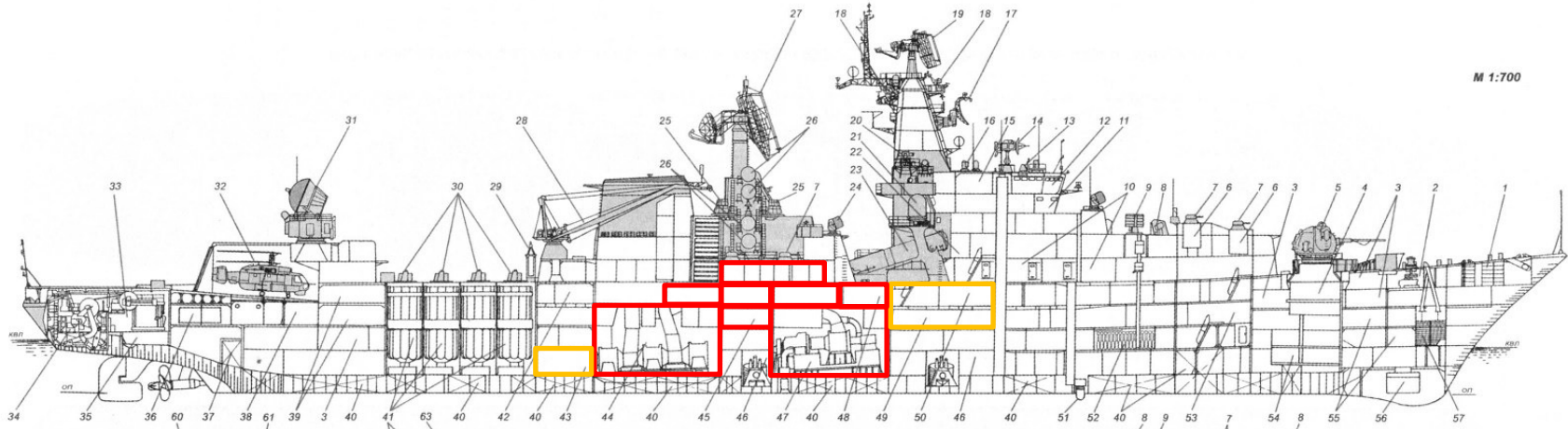

- ◆ **One missile impacted near the waterline at, or just aft, of the forward engine room.**
- ◆ **Second missile impacted a bit higher just below the port AK-630 mounts.**
  - **Serious fires broke out due to the explosions and remaining fuel.**
    - **Flight range was about 65 nmi, out of a maximum range of 151 nmi.**
  - **Reportedly a “magazine explosion” occurred – likely AK-630 magazine.**
- ◆ ***Moskva* suffered a loss of all propulsion and electrical power.**





# Moskva Missile Damage

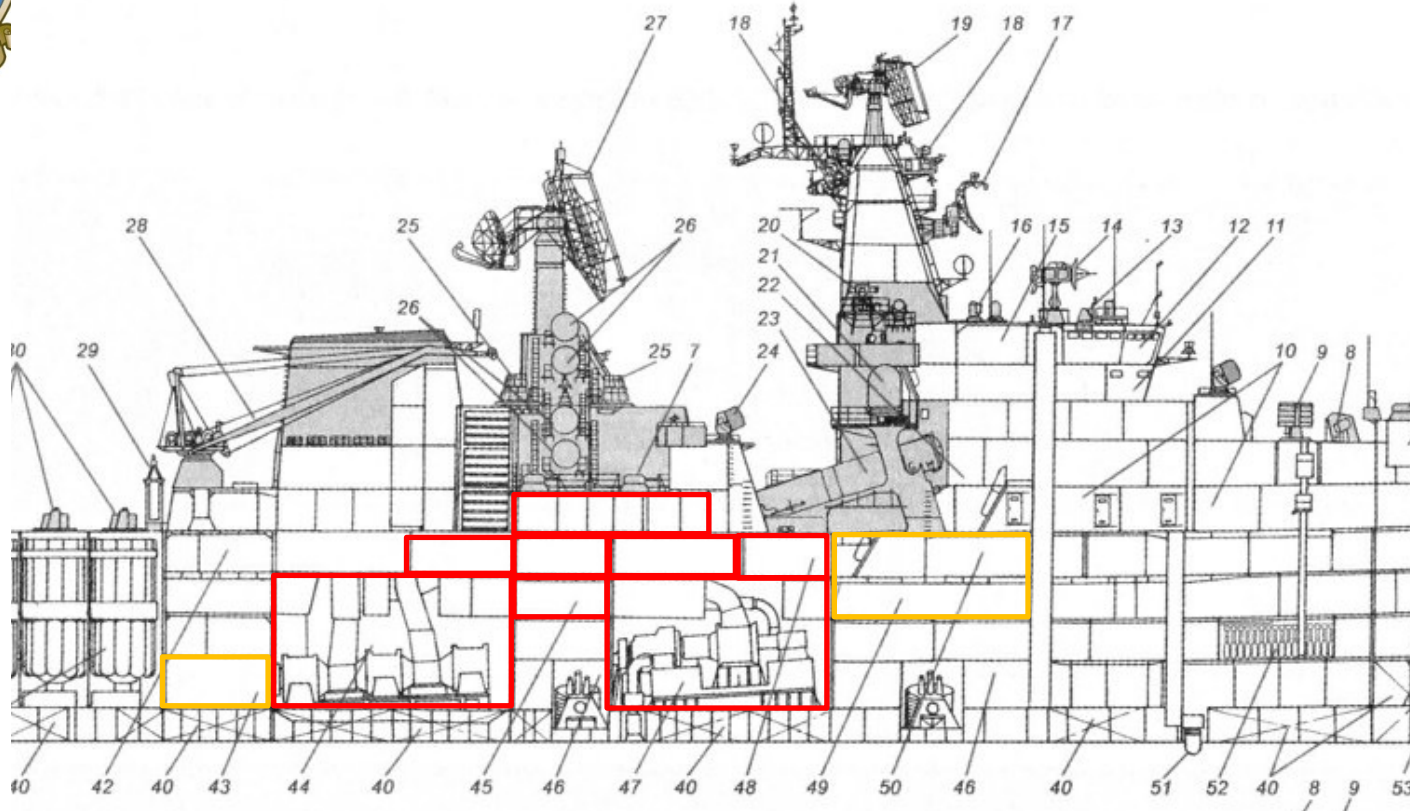

- ◆ 44 – Aft engine room (“afterburner” or boost gas turbine engines)
- ◆ 45 – Post of Energy and Survivability (PEJ)
- ◆ 47 – Forward engine room (“marching” or cruise gas turbine engines)
- ◆ 43 & 48 – Electrical power generation
- ◆ 49 – Combat Information Post



# Moskva Propulsion Plant

## Project 1164 Propulsion Plant

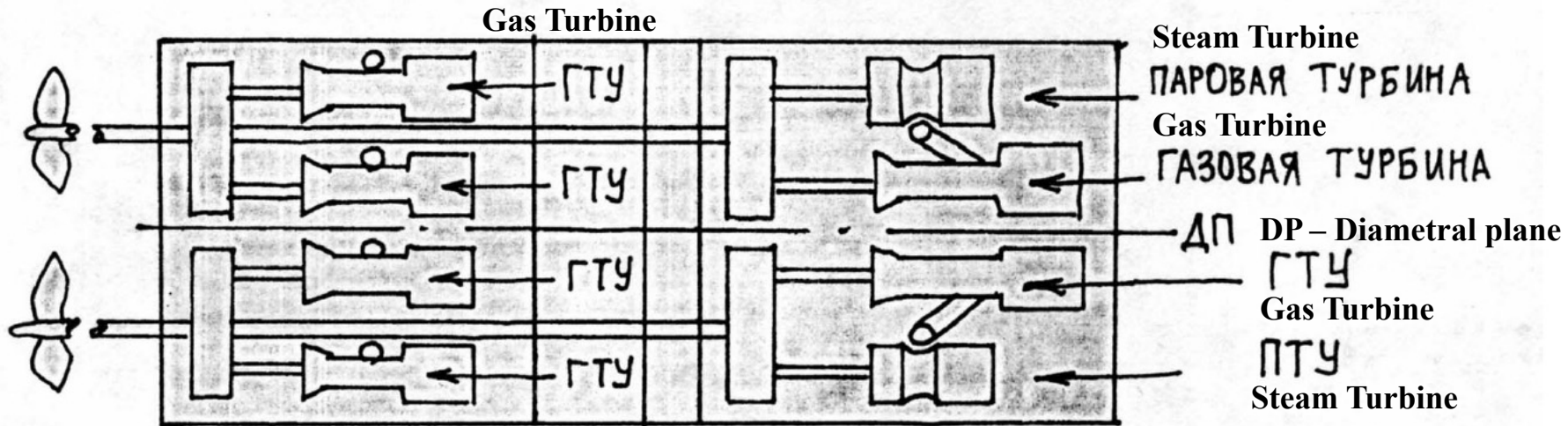

## Project 1134B Propulsion Plant

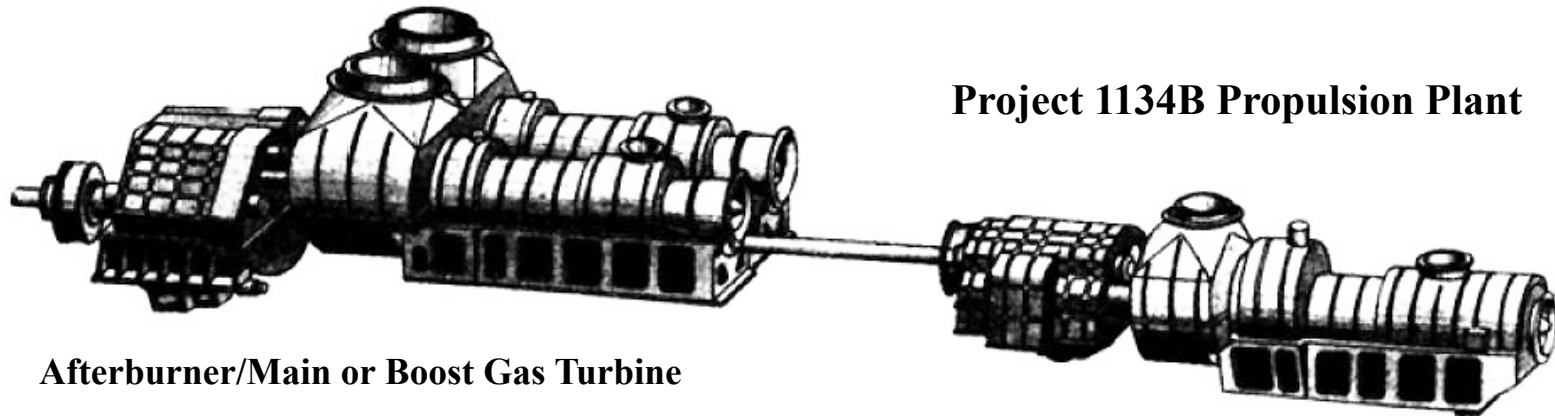

Afterburner/Main or Boost Gas Turbine

Marching or Cruise Gas Turbine



# DD 963 *Spruance* Propulsion Plant

- ◆ U.S. Navy ship design practice tends to have separated propulsion plant compartments.
  - Less likely that one ASCM would cause a loss of all propulsion.
- ◆ *Moskva's* propulsion plant design is more vulnerable to battle damage.
  - Cruise and boost gas turbines engines are collocated in the same compartment.
  - Complex shared shaft arrangement.
- ◆ A single hit in either engine room on a *Slava* class cruiser could result in a total loss of propulsion.
  - This is apparently what happened as *Moskva* had to be towed back to Sevastopol.

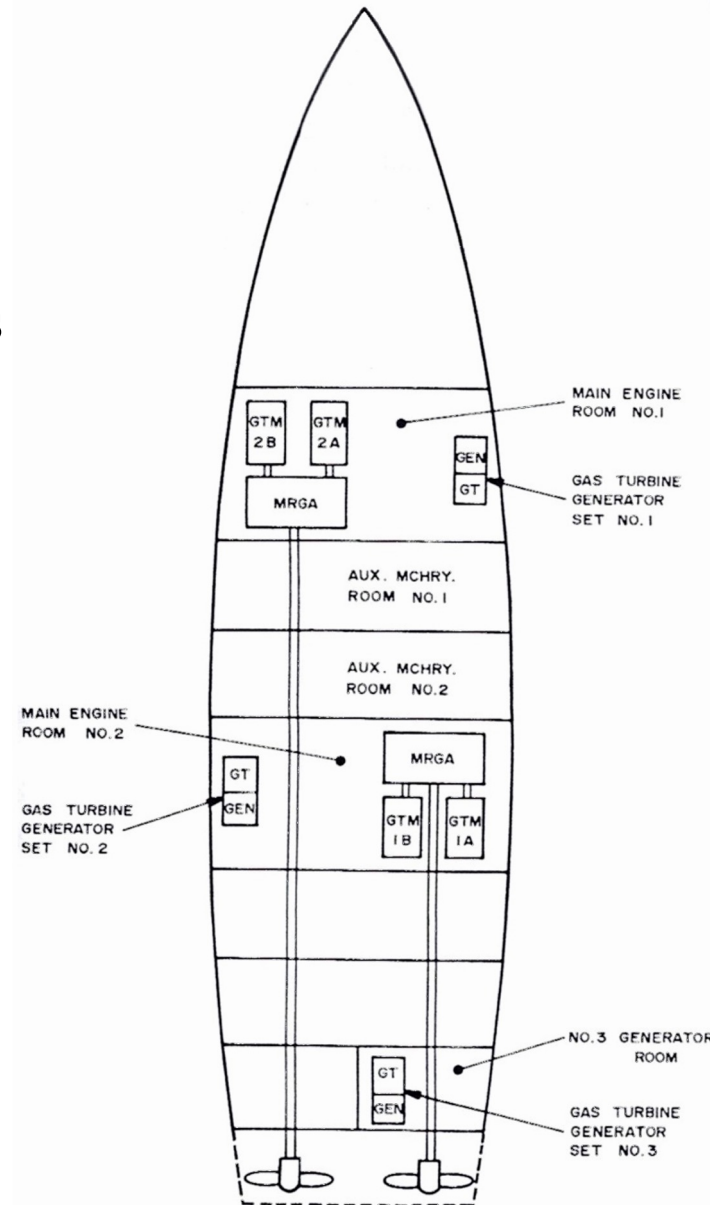



# Post of Energy and Survivability

- ◆ **The Post of Energy and Survivability (PEJ) is critical to this incident:**
  - **A major electrical system distribution node.**
  - **Automated damage control central.**
    - **Collects, analyses, and disseminates information that support ship's damage control activities.**
    - **Controls remote fire extinguishing systems, pumps to dewater flooded compartments, manage list control, etc.**
    - **The first line of damage control for Russian ships.**
- ◆ **Manual damage control is taught and practiced to some degree but is definitely a secondary line of defense.**
  - **Requires dedicated and consistent training to achieve and maintain an acceptable level of competency – difficult with short term conscripts.**
- ◆ **A topside deck level tour of *Marshal Ustinov* in 1989 indicated far less fire fighting equipment and fittings than on U.S. warships.**



# Moskva Secondary Damage



- ◆ **Flooding at the impact location.**
  - Progressive flooding to other compartments occurred as the ship took on  $\approx 15$  degree list to port.
- ◆ **Fire was not contained and appears to have spread quite far aft.**
  - Soot marks visible from portholes and port torpedo tube shutter door.



This photo was taken after the crew had abandoned ship. Note the very calm seas.



# *Moskva* Damage Summary

- ◆ **Two cruise missiles with 145 kg high-explosive warheads caused significant damage to the ship as well as flooding and fire.**
- ◆ **The AK-630 magazine appears to have cooked off causing additional fragmentation and fire damage.**
- ◆ **The forward engine room was seriously damaged, and the ship lost all propulsion. *Moskva* would have to be towed back to Sevastopol.**
- ◆ **Damage to the PEJ resulted in a loss of electrical power and the ability to fight the casualties remotely.**
- ◆ ***Moskva* apparently did not have her watertight doors closed as fire appears to have spread all the way back to the helicopter hangar.**
- ◆ **Progressive flooding caused the ship to take  $\approx 15$  degree list to port.**
- ◆ **Crew appears to have had little impact on the fire and flooding.**
  - **Reflects a lack of training and potentially insufficient manual damage control equipment.**



# Moskva Sank on 14 April



## Possible Oil Slicks From Russian Navy Cruiser Moskva



Sentinel-1 radar satellite (SAR) imagery

H I Sutton Twitter: @CovertShores, Website: [www.hisutton.com](http://www.hisutton.com)



General vicinity of Moskva attack, April 13



Slick observed  
April 20, 15:44 UTC



Slick observed  
April 20, 15:44 UTC



Slick observed  
April 24, 04:05 UTC

Yevpatoriya

Simferopol

Sevastopol

Sevastopol

Credit: European Union, contains modified Copernicus Sentinel data 2022, processed with EO Browser

Copernicus sentinelhub





# Comparison with HMS *Sheffield*

- ◆ ***Moskva*'s sinking is not quite the same as the loss of HMS *Sheffield*.**
  - While both ships were sunk by transonic, sea skimming ASCMs, there are considerable differences between the engagements.
- ◆ ***Sheffield* only had soft kill (chaff) as a defense against an Exocet.**
  - Type 965R radar could not detect a sea skimming missile.
  - Sea Dart had a very limited ability to intercept a missile that low.
  - No point defenses other than a crew served 20mm.
  - ESM gear was self-jammed by the ship's SATCOM.
- ◆ ***Moskva* had far more defensive capability than *Sheffield*, but none of the systems appear to have been employed in the defense of the ship.**
  - MR-800 and MR-710M radars could detect sea skimming missiles.
    - MR-800 was not jammed by SATCOM; it was the other way around.
  - S-300F and Osa-MA SAMs had some capability to intercept the missiles.
  - AK-630 Gatling guns were designed to defend against this threat.





# Conclusions

- ◆ ***Moskva*'s loss was due to a fatal combination of many factors:**
  - She was an old ship, with very few upgrades to her combat system, sensors, and air defense weapons.
  - A long list of material deficiencies that affected her ability to fight.
  - A crew that, by all appearances, did not respond to the incoming threat, nor were they able to fight the resulting fire and flooding.
  - The rapid loss of all propulsion, electrical power, coupled with the crippling of *Moskva*'s first-line of damage control capabilities severely degraded her ability to respond to the fire and flooding casualties.
- ◆ **In sum, *Moskva* was not ready for combat operations and the Russian leadership was complacent about the threat to Black Sea Fleet ships.**
- ◆ ***Moskva*'s loss was not due to a “spontaneous fire” followed by floundering in heavy seas.**
  - AK-630 magazine unlikely to cause sinking damage to the ship.
  - Sea state was low; the seas were calm.



# Questions





# Primary References

**Ships of the Soviet Navy 2<sup>nd</sup> Volume, Attack Ships, Part 1: Aircraft carriers, Rocket and Artillery Ships by Y. V. Apalkov**

**Soviet Navy 1945-1995: Cruisers, Large Antisubmarine Warfare Ships, Destroyers by S.S. Berezhnov**

**Aircraft Carrier Killers by A.S. Pavlov**

**The Soviet Navy 1945-1991 by V.P. Kuzin and V.I. Nikol'sky**

**Russia's Arms Catalog Volume III, Navy, 1996-97, published by Military Parade**

**Russia's Arms and Technologies, The XXI Century Encyclopedia, Naval Weapons, published by Arms and Technologies Publishing House**

**Armament of the Russian Navy, 1996, by Sudostroenie**

**The Naval Institute Guide to World Naval Weapon Systems 1997-1998 by Dr. Norman Friedman**

**40 Years of Missile Warfare: What the Losses of HMS Sheffield and RFS Moskva Tell us about War at Sea, <https://cimsec.org/40-years-of-missile-warfare-what-the-losses-of-hms-sheffield-and-rfs-moskva-tell-us-about-war-at-sea/>**

**Modernization of the missile cruiser Project 1164, <https://alternathistory.com/modernizatsiya-raketnyi-kreiser-proekta-1164/>**

**Project 1164 Cruisers, <https://war-book.ru/krejsera-proekta-1144-2/>**

**Guided Missile Cruisers: Project 1164 Atlant, [russianships.info/eng/warships/project\\_1164.htm](https://russianships.info/eng/warships/project_1164.htm)**

**Project 1164 Atlant missile cruisers of the Slava class, [https://wiki.wargaming.net/ru/Navy:Ракетные\\_крейсера\\_типа\\_«Слава»\\_проекта\\_1164\\_«Атлант»](https://wiki.wargaming.net/ru/Navy:Ракетные_крейсера_типа_«Слава»_проекта_1164_«Атлант»)**

**Project 1164 Atlant light missile cruisers, [www.and-kin2008.narod.ru/pr1164.html](http://www.and-kin2008.narod.ru/pr1164.html)**

**Missile Cruiser of Project 1164 Atlant, <http://bastion-karpenko.ru/1164-atlant/>**

**Missile Cruiser "Slava", [lemur59.ru/node/506](http://lemur59.ru/node/506)**

**Granger on Twitter, <https://twitter.com/GrangerE04117/status/1522643831736332288>**

**Naval Graphics on Twitter, [https://twitter.com/naval\\_graphics?lang=en](https://twitter.com/naval_graphics?lang=en)**

**Neptune 360 MTs Rocket System brochure, Luch, State Kyiv Design Bureau**

**R-360 Neptune: a cruise missile which burnt Moskva, <https://mezha.media/en/2022/04/14/r-360-neptune-a-cruise-missle-which-burnt-moskva/>**

**Bayraktar TB2: Unmanned Aerial Combat Vehicle, [www.military-today.com/aircraft/bayraktar\\_tb2.htm](http://www.military-today.com/aircraft/bayraktar_tb2.htm)**

**Bayraktar TB2 brochure by Baykar Technology**

**Russia Ministry of Defense**

**Ukraine Ministry of Defense**

**Livejournal**

**Covert Shores**

**Naval News**

**TASS**

**BBC**

**Daily Telegraph**

**The Guardian**

**The Hill**